

Mach4 CNC Controller

Mill Programming Guide

Version 1.0

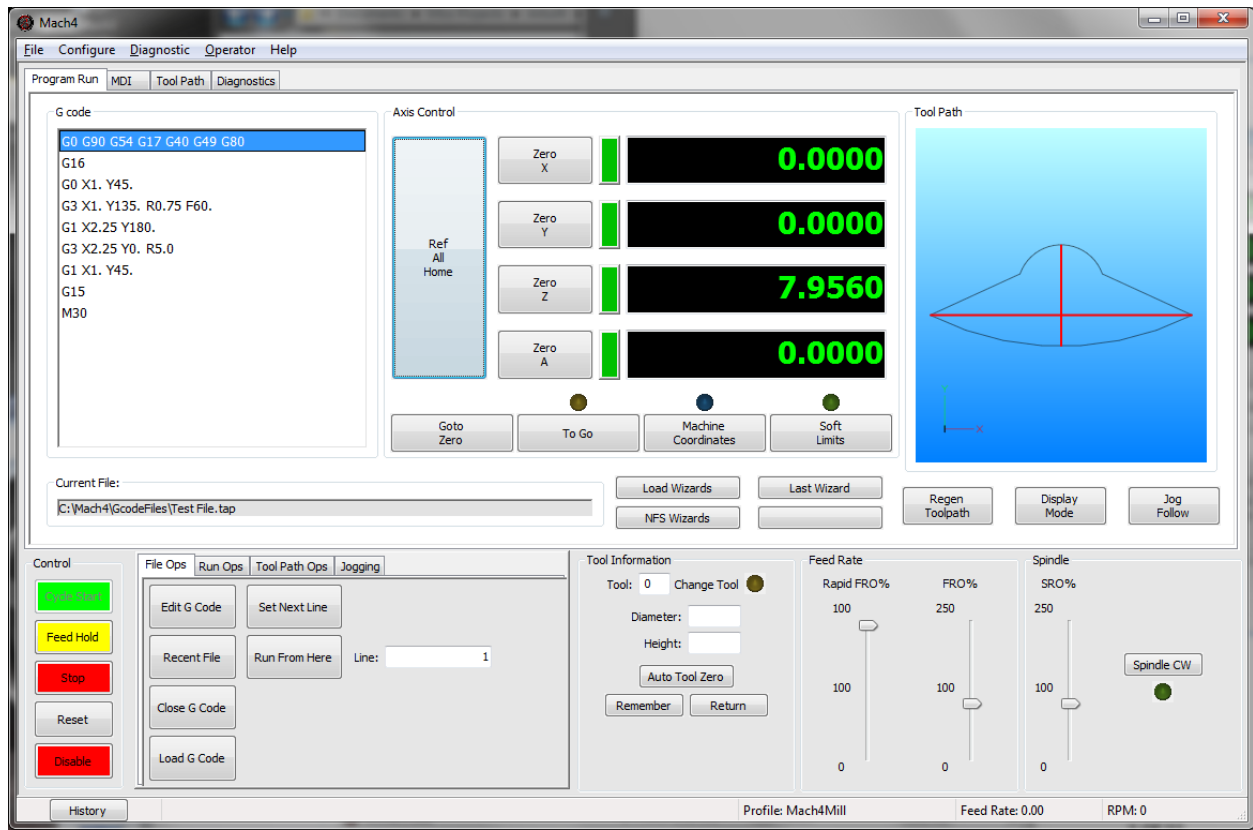

Copyright © 2014 Newfangled Solutions, Artsoft USA, All Rights Reserved

The following are registered trademarks of Microsoft Corporation: Microsoft, Windows. Any other trademarks used in this manual are the property of the respective trademark holder.

Table of Contents

Chapter 1: Introduction	2
Glossary.....	3
Format.....	4
Chapter 2: G Code List.....	5
G Code Descriptions and Examples.....	7
Chapter 3: Canned Cycles	33
Drilling.....	35
Tapping.....	40
Boring.....	43
Chapter 4: Cutter Compensation	50
Chapter 5: M Code List.....	56
M Code Descriptions.....	56

Chapter 1: Introduction

G Code is a special programming language that is interpreted by Computer Numerical Control (CNC) machines to create motion and other tasks. It is a language that can be quite complex at times and can vary from machine to machine. The basics, however, are much simpler than it first appears and for the most part follows an industry adopted standard. Mach4 has made a large leap closer to this standard.

An important point to remember when reading this manual: In describing motion of a machine it will always be described as tool movement relative to the work piece. In many machines the work piece will move in more axes than the tool; however the program will always define tool movement around the work piece. Axes directions follow the right hand rule, see figure A.

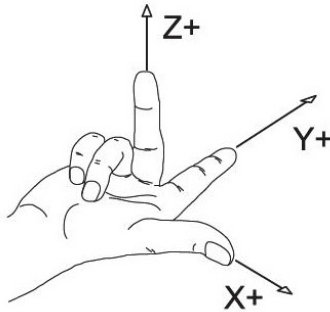

Figure A: Right hand rule

Glossary

Block	A single line of G Code
Canned Cycle	Complex cycle defined by a single block of code
Dwell	Program pause with a duration defined by "P" in seconds
EOB	End of block. Required at the end of every block of G Code. In Mach4 this is a carriage return
Feedrate	Velocity, set by F, at which an axis will move
Group	Collection of G codes that control the same function or mode, i.e. G90 and G91 positioning modes
Modal	Active until a code from the same group is called
Normal	A line perpendicular to a plane, pointing in the positive direction.
Origin	Point in a coordinate system where X, Y and Z are zero
RPM	Revolutions per minute
UPM	Units per minute (inches, millimeters, degrees, etc)
Word	A single word of G Code is a letter followed by a number. G01, X1.0, etc. are words

G	Preparatory function, G followed by a numerical code, specifies machining modes and functions
M	Miscellaneous function, M followed by a numerical code, defines program flow and can control auxiliary functions such as coolant. Can also perform machine specific functions and macros user or builder.
X, Y, Z, A, B, C	Movement commands followed by a numerical value, define the end point of a motion command
S	Spindle speed, followed by numerical value of desired rpm or surface speed
T	Tool call, followed by next tool number to be used
H	Tool height offset to be used, generally matches the tool number
D	Tool diameter offset to be used, generally matches the tool number
F	Followed by a numerical value to define the feedrate. The magnitude and value of which will be determined by the feed mode setting
P	Followed by a numerical value, specifies dwell time in seconds. (also used in other functions)

N	Sequence numbers. Used for program organization and go to commands
---	--------------------------------------------------------------------

Format

In writing G Code programs there are some rules to be aware of as well as some general formatting guidelines that should be followed or at least considered.

The first part of any program should be a safe start up block. This line of code is used to make sure that some modes are disabled and others are set to their most common setting. An example safe start block would look like this:

```
G00 G90 G17 G54 G40 G49 G80
```

This block of code tells the machine that we want to be in rapid mode and using absolute position in the XY plane of fixture offset 1. At the same time we want to cancel any tool diameter and length offsets and make sure any active canned cycles are cancelled.

G00 – Rapid mode

G90 – Absolute position mode

G17 – XY plane select

G54 – Fixture offset 1

G40 – Cutter compensation (tool diameter) cancel

G49 – Length offset cancel

G80 – Canned cycle cancel

It is recommended that this safe start block be used at the start of the program and also before or immediately following every tool change. It is common to restart a program from a tool change, having the safe start line there can greatly reduce the chance of a machine not acting as expected, the results of which can be aggravating at best and a crash at worst. The safe start block shown here is just an example. Every machine and every programmer are a little different and each will have their own start up block.

Jumping to the end of the program there is not a lot required. Typically there will be a couple blocks of code to return the Z axis to the home position and maybe move the work piece closer to the operator for easier loading and unloading of parts. Shutting off the spindle and coolant or any other accessories is also a good idea here. The final block in a program is a program end code, most commonly M30 but there are other options. Make sure this final block is followed by an end of block. It is easy to forget this last EOB in a program for Mach because it is just a carriage return and not always readily apparent. One way to make sure that there is always an EOB on your program end block is to follow it with %. Like this:

```
.  
. .  
. .  
M30
```

%

This percent sign is a familiar symbol to CNC programmers in industry; however any symbol or character can be used as it will not be read by the control because of the program end before it. If there is no EOB following the percent sign it will not show up in the program when loaded into Mach.

In between the start and end is the body of the program. There are a few rules here. Each block of code will contain a combination of words. Multiple G codes can be specified in a single block, however if more than one from the same modal group is specified the last one in the block will be valid, with the exception of group 00. Modal G codes stay active until another from the same group is called. For example; G01 is modal so it is not necessary to put it in consecutive blocks. Once active every successive positioning block will be in the G1 mode unless another code from group one is called (G00, G02, G03, etc.). All G codes not in group 0 behave this way.

Only one M code can be specified in a single block. Same holds true for all other words.

Generally leading zeroes are not required in G Code. For example G01 and G1 are the same. The same holds true for M codes, position commands, feedrates, etc. When specifying values for position, feedrate, variables, etc., it is good practice to always use a decimal point and trailing zero, instead of X1 use X1.0. Although the decimal point is not required (in Mach X1 = X1.0) it is HIGHLY recommended.

Chapter 2: G Code List

Code	Group	Description	Modal	Page
G00	1	Rapid Move	Y	7
G01	1	Linear Feed Move	Y	7
G02	1	Clockwise Arc Feed Move	Y	8
G03	1	Counter Clockwise Arc Feed Move	Y	8
G04	0	Dwell	N	11
G09	0	Exact stop	N	11
G10	0	Fixture and Tool Offset Setting	N	12
G12	1	Clockwise Circle	Y	15
G13	1	Counter Clockwise Circle	Y	15
G15	11	Polar Coordinate Cancel	Y	15
G16	11	Polar Coordinate	Y	15
G17	2	XY Plane Select	Y	17
G18	2	ZX Plane Select	Y	17
G19	2	YZ Plane Select	Y	17
G20	6	Inch	Y	18
G21	6	Millimeter	Y	18
G28	0	Zero Return	N	18
G30	0	2 nd , 3 rd , 4 th Zero Return	N	20

G31	1	Probe function	N	20
G32	1	Threading*	N	20
G40	7	Cutter Compensation Cancel	Y	20
G41	7	Cutter Compensation Left	Y	22
G42	7	Cutter Compensation Right	Y	22
G43	8	Tool Length Offset + Enable	Y	22
G44	8	Tool Length Offset - Enable	Y	22
G49	8	Tool Length Offset Cancel	Y	22
G50	9	Cancel Scaling	Y	23
G51	9	Scale Axes	Y	23
G52	0	Local Coordinate System Shift	Y	23
G53	0	Machine Coordinate System	N	24
G54	12	Fixture Offset 1	Y	25
G54.1	12	Additional Fixture Offsets	Y	25
G55	12	Fixture Offset 2	Y	25
G56	12	Fixture Offset 3	Y	25
G57	12	Fixture Offset 4	Y	25
G58	12	Fixture Offset 5	Y	25
G59	12	Fixture Offset 6	Y	25
G60	0	Unidirectional Approach	N	25
G61	13	Exact Stop Mode	Y	25
G64	13	Cutting Mode (Constant Velocity)	Y	26
G65	0	Macro Call	N	26
G66		Macro Modal Call	Y	27
G67		Macro Modal Call Cancel	Y	27
G68	15	Coordinate System Rotation	Y	26
G69	15	Coordinate System Rotation Cancel	Y	28
G73	16	High Speed Peck Drilling	Y	39
G74	16	LH Tapping*	Y	42
G76	16	Fine Boring*	Y	43
G80	16	Canned Cycle Cancel	Y	35
G81	16	Hole Drilling	Y	35
G82	16	Spot Face	Y	37
G83	16	Deep Hole Peck Drilling	Y	38
G84	16	RH Tapping	Y	40
G84.2	16	RH Rigid Tapping*	Y	42
G84.3	16	LH Rigid Tapping*	Y	42
G85	16	Boring, Retract at Feed, Spindle On	Y	44
G86	16	Boring, Retract at Rapid, Spindle Off	Y	45
G87	16	Back Boring*	Y	46
G88	16	Boring, Manual Retract	Y	48

G89	16	Boring, Dwell, Retract at Feed, Spindle On	Y	49
G90	3	Absolute Position Mode	Y	29
G90.1	4	Arc Center Absolute Mode	Y	30
G91	3	Incremental Position Mode	Y	29
G91.1	4	Arc Center Incremental Mode	Y	30
G92	0	Local Coordinate System Setting	Y	31
G92.1	0	Local Coordinate System Cancel	Y	31
G93	5	Inverse Time Feed	Y	32
G94	5	Feed per Minute	Y	32
G95	5	Feed per Revolution*	Y	32
G96	14	Constant Surface Speed*	Y	32
G97	14	Constant Speed	Y	32
G98	10	Initial Point Return	Y	32
G99	10	R Point Return	Y	33

* Implementation based on machine and control configuration

G Code Descriptions and Examples

Note:

For clarity rotational moves have been omitted from this manual.
All motion commands can also contain A, B, and/or C axis motion.

G00 – Rapid move: Rapid moves are used to move from point to point in free space, not cutting material. These moves do not require a feed rate input as they take place at max velocity of the machine. In absolute position mode (G90) X, Y and Z define the end point of the move in the user coordinate system. In incremental position mode (G91) X, Y and Z define the distance and direction to move from the current position.

Format: G00 X__ Y__ Z__

Example: Program a rapid move to X1.0, Y3.0

G0 G90 G54 G17 G40 G49 G80	Safe start line
T1 M6	Tool change
S2500 M3	Start spindle
G0 X1.0 Y3.0	Rapid to XY position
M30	Program end and rewind

G01 – Linear Feed Move: Linear feed moves are point to point moves in a straight line at a feedrate specified by F. The moves are interpolated so all axes in motion reach the end point at the same time. In absolute position mode (G90) X, Y and Z define the end point of the move in the user coordinate system. In incremental position mode (G91) X, Y and Z define the distance and direction to move from the current position.

Format: G01 X__ Y__ Z__ F__.

Example: Program a feed move from X1, Y3, to X10, Y-1 at a feedrate of 15 UPM.

G0 G90 G54 G17 G40 G49 G80	Safe start line
T1 M6	Tool change
S2500 M3	Start spindle
G94	Feed per minute mode
G0 X1.0 Y3.0	Rapid to XY position
G1 X10.0 Y-1.0 F15.0	Move to XY position at feedrate
M30	Program end and rewind

G02/G03 – Arc Feed Move: Used to cut an arc at a feedrate specified by F. An arc is defined by its start and end points, its radius or center point, a direction, and a plane. Direction is determined by G02, clockwise, and G03, counterclockwise, when viewed from the plane's positive direction (If XY plane is selected look down so that the X axis positive direction is pointing to the right, and the Y axis positive direction is pointing forward). See figure 2-1 for a graphic representation of the motion of a G02. The start point is the current position of the machine. Specify the end point with X, Y, and Z. The values input for the end point will depend on the current G90/G91 (abs/inc) setting of the machine. Only the two points in the current plane are required for an arc. Adding in the third point will create a helical interpolation.

Next is to specify the radius or the center point of the arc, only one or the other, not both.

- To specify the radius, use R and input the actual radius of the desired arc, see Format 2. When an arc is created knowing only start and end points and a radius there are two possible solutions, an arc with a sweep less than 180° and one with sweep greater than 180°. The sign of the radius value, positive or negative, determines which arc will be cut, see figure 2-2. A positive value for R cuts an arc with sweep less than 180°. A negative value for R cuts an arc with sweep greater than 180°.
- A more accurate and reliable way to define an arc is by specifying the center point, this is done with arguments I, J, and K, see Format 1. The center point must be defined in the current plane. I, J, and K correspond to X, Y, Z respectively; the current plane selection will determine which two are used. XY plane (G17) would use I and J for example. Mach has two settings for how I, J, and K should be specified, absolute and incremental. This setting can be changed by G code, G90.1 and G91.1, or in the general tab in the Mach configuration. This setting is independent of the G90/G91 setting. If arc center mode is set to incremental then I, J, K are the distance and direction from the start point to the center point of the arc. If arc center mode is set to absolute then I, J, K are the absolute position of the arc center point in the current user coordinate system.

Format 1: (G17) G02/03 X__ Y__ I__ J__ F__
(G18) G02/03 X__ Z__ I__ K__ F__

(G19) G02/03 Y__ Z__ J__ K__ F__
 Format 2: (G17) G02/03 X__ Y__ R__ F__
 (G18) G02/03 X__ Z__ R__ F__
 (G19) G02/03 Y__ Z__ R__ F__

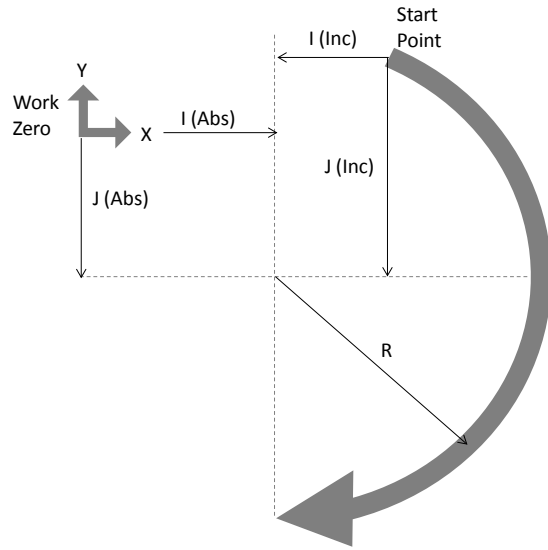

Figure 2-1: Path of tool point in circular and helical interpolation (G02).

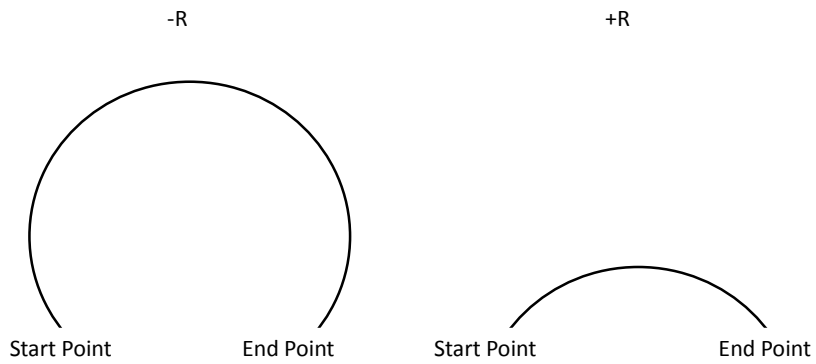

Figure 2-2: Difference between negative and positive values for R

Example: Program an arc centered at 1.0, 0.0 in the XY plane with radius 2. Start point at 3.0,0.0 and sweep 90 degrees counter clockwise. Feedrate 10 UPM. (Arc center mode set to incremental)

Format 1:

G0 G90 G54 G17 G40 G49 G80	Safe start line
T1 M6	Tool change
S2500 M3	Start spindle
G0 X3.0 Y0.0	Position to X and Y start point
G43 H1 Z.5	Activate tool offset 1 and move to Z rapid plane
G94	Feed per minute mode
G1 Z0.0 F10.0	Z plunge at feedrate
G3 X1.0 Y2.0 I-2.0 J0.0 F10.0	Arc move
G0 Z.5	Retract Z to rapid plane
G0 G53 Z0.0	Return Z to home
M30	Program end and rewind

Format 2:

G0 G90 G54 G17 G40 G49 G80	Safe start line
T1 M6	Tool change
S2500 M3	Start spindle
G0 X3.0 Y0.0	Position to X and Y start point
G43 H1 Z.5	Activate tool offset 1 and move to Z rapid plane
G94	Feed per minute mode
G1 Z0.0 F10.0	Z plunge at feedrate
G3 X1.0 Y2.0 R2.0 F10.0	Arc move
G0 Z.5	Retract Z to rapid plane
G0 G53 Z0.0	Return Z to home
M30	Program end and rewind

A helical interpolation is defined very similar to an arc. The only difference is the addition of the third coordinate of the end point. This third coordinate will define the height of the helix. See the following format for what this looks like in the XY plane:

Format 1: (G17) G02/03 X__ Y__ Z__ I__ J__ F__

Format 2: (G17) G02/03 X__ Y__ Z__ R__ F__

Example: Program a helix with radius 1.0 and center point 0.0, 0.0 in the X,Y plane, start point 0.0, .5, height 1.0 with initial Z at 0.0. Feedrate 10 UPM. Arc sweep should be 270° clockwise. See figure 2-2 for the tool path.

G0 G90 G54 G17 G40 G49 G80	Safe start line
T1 M6	Tool change
S2500 M3	Start spindle
G0 X0.0 Y.5	Position to X and Y start point
G43 H1 Z.5	Activate tool offset 1 and move to Z rapid plane
G94	Feed per minute mode

G1 Z0.0 F10.0	Z plunge at feedrate
G2 X-.5 Y0.0 Z-1.0 I0.0 J-.5 F10.0	Helical interpolation
G0 Z.5	Retract Z to rapid plane
G0 G53 Z0.0	Return Z to home
M30	Program end and rewind

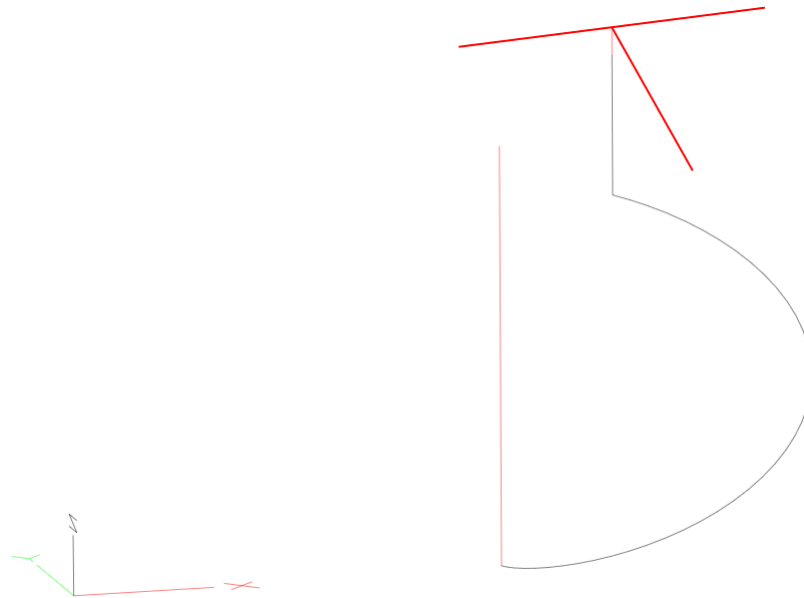

Figure 2-2: Helical interpolation example toolpath

G04 – Dwell: A dwell is simply a pause in the program. The duration of the dwell is specified by P in seconds. No machine movement will take place during a dwell. No auxiliary codes will be turned off, i.e. if the spindle is on it will stay on, coolant will stay on, etc.

Format: G04 P__

Example: Program a 5 second dwell after positioning to X1.0, Y1.0, Z.5.

G0 G90 G54 G17 G40 G49 G80	Safe start line
T1 M6	Tool change
S2500 M3	Start spindle
G0 X1.0 Y1.0	Rapid to XY position
Z.5	Rapid to Z position
G4 P5.	Dwell for 5 seconds
M30	Program end and rewind

G09 – Exact Stop: G09 is a non modal exact stop. Machine accelerations cause corners to be slightly rounded; when a true sharp corner is required G09 should be used. Although similar to G61 in function, G09 is not modal while G61 is. When G09 is included in a movement block, axis motion is decelerated to the end point of motion and the position is checked to be exactly as specified. This position check at the

end of the move ensures that the machine actually reaches the desired position before moving onto the next block

Format: G01 G09 X__ Y__ F__

Example: Program a 2.0 inch square centered at X0.0, Y0.0 with true sharp corners at X1.0, Y1.0 and X-1.0, Y-1.0, feedrate 15.0 UPM

G0 G90 G54 G17 G40 G49 G80	Safe start line
T1 M6	Tool change
S2500 M3	Start spindle
G94	Feed per minute mode
G0 X-1.0 Y1.0	Rapid to XY position
G1 G9 X1.0 F15.0	Move to position at feedrate, exact stop active
Y-1.0	Move to position at feedrate
G9 X-1.0	Move to position at feedrate, exact stop active
Y1.0	Move to position at feedrate
M30	Program end and rewind

Figure 9-1 shows what this square would look like, slightly exaggerated.

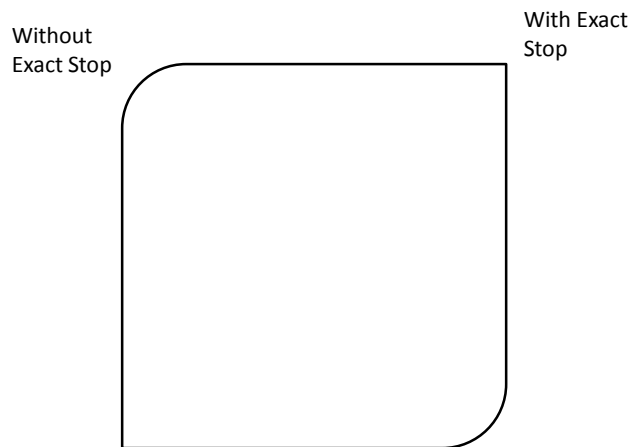

Figure 9-1: Square with exact stop on two corners

G10 – Fixture and Tool Offset Setting: It is possible to set fixture and tool offsets in the program. This can be very useful for programming multiple fixtures that have known zero points, multi pallet machines, applying automatic compensation of tool wear, and many other situations that require changing offset values. G10 is also one of the least understood G codes and is therefore underutilized.

Changing offset values in a program requires a bit of cautiousness, a mistake can easily result in ruined parts and damaged tools. When used properly however, G10 can add flexibility and safety to a program and machine, especially with automation and lights out capacity or inexperienced operators.

Starting with fixture offset setting the G10 block will look like the following:

Format: G10 L2 P__ X__ Y__ Z__ A__ B__ C__

L selects the function of the G10 block, different values will have different functions. L2 is the designation for fixture offset setting. The value of P specifies which offset is being set. For the basic 6 fixture offsets P values are as follows:

Fixture offset (G__)	P__
54	1
55	2
56	3
57	4
58	5
59	6

The data for the fixture offset is set by X, Y, Z, A, B, C.

X	X axis offset
Y	Y axis offset
Z	Z axis offset
A	A axis offset
B	B axis offset
C	C axis offset

All values do not need to be specified, only the ones to be set. If, for example, a Z is not programmed it simply will not be changed in the fixture offset.

In G90, absolute, mode the values in the G10 line will be directly input into the fixture offset. When in G91, incremental, mode the values will be **added** to the desired fixture offset. This is a major difference in functionality and care should be taken to make sure the right mode is active for the desired effect.

Example: Set G56 fixture offset to X-8.0, Y-3.0, Z-5.0, A45.0 in a program.

G0 G90 G54 G17 G40 G49 G80	Safe start line
G10 L2 P3 X-8.0 Y-3.0 Z-5.0 A45.0	Set G56 fixture offset values
M30	Program end and rewind

Additional fixture offsets, G54.1 Pxx, can also be set using G10. Setting of these offsets is the same, except it is done using L20. The legacy additional fixture offsets (see fixture offset section of this manual for more details) can still be set with G10. The following table shows the additional fixture offset P

number and its corresponding G10 P number as well as the legacy offsets. Note that G54.1 P1 is the same offset as G59 P7, so G10 L20 P1 and G10 L2 P7 both set the same offset values.

G54.1 P__	G10 L20 P__	Legacy G59 P__	Legacy G10 L2 P__
1	1	7	7
2	2	8	8
3	3	9	9
-	-	-	-
-	-	-	-
-	-	-	-
248	248	254	254

Example: Set G54.1 P5 fixture offset to X3.0, Y3.4, Z-10.0 in a program.

G0 G90 G54 G17 G40 G49 G80	Safe start line
G10 L20 P5 X3.0 Y3.4 Z-10.0	Set G54.1 P5 fixture offset values
M30	Program end and rewind

Work shift and head shift can also be set with G10. Work shift is set using G10 L2 P0. Head shift is set using G10 L20 P0. Notice the L20 for head shift. All other values are set in the same format as the other fixture offsets.

Tool offset setting requires just as much care as setting of fixture offsets. G90 and G91 affect the setting of offset values in the same way. G90 causes the current value to be over written with the value in the G10 block, while G91 adds the value from the G10 block to the current value.

Format: G10 L1 P__ Z__ W__ D__ R__ X__ U__ Y__ V__ Q__

Again, not all values are required, if omitted that value simply will not be set. L1 specifies tool offset setting, P is again the offset number to be set (offset #1 = P1, offset #2 = P2, etc.). The remaining arguments specify the type and value of offset to be set.

Z	Height offset
W	Height wear offset
D	Diameter offset
R	Diameter wear offset
X*	X offset
U*	X wear offset
Y*	Y offset
V*	Y wear offset
Q	Tool pocket

*Future feature not yet implemented

Example: Set height of tool offset #5 to 1.5. Add .05 to offset #2 diameter wear.

G0 G90 G54 G17 G40 G49 G80	Safe start line
-----------------------------------	-----------------

G10 L1 P5 Z1.5	Set tool offset 5 height to 1.5
G91	Set incremental to add to offset
G10 L1 P2 R.05	Add .05 to tool offset #2 diameter wear
M30	Program end and rewind

G12/G13 – Circle Interpolation: These codes are used to cut a circle using the current position as the center point. Words, I and J, define the radius of the circle and the lead-in direction. G12 will cut a circle in the clockwise direction and G13 will cut in the counterclockwise direction. It is also possible to cut a larger circular pocket by specifying Q for the start radius and P for the step over amount. This can be useful for cutting a circular pocket or an ID groove.

Format 1: G12/13 I__ J__ F__

Format 2: G12/13 I__ J__ P__ Q__

See figure 12-1 for a graphic of the motion. The current position will be the center of the circle.

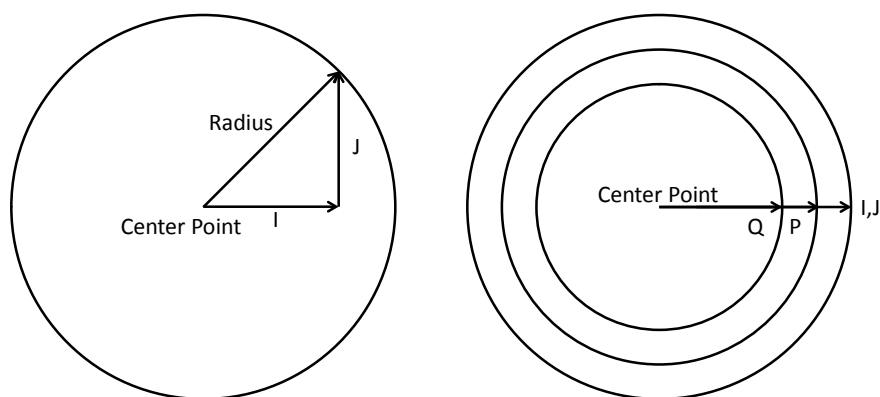

Figure 12-1: Tool motion during circle interpolation

Example: Cut a 1.0 inch radius circle centered at X1.5 Y0.25. Lead-in along the X axis.

G0 G90 G54 G17 G40 G49 G80	Safe start line, absolute mode, XY plane
G0 X1.5 Y.25	Move to initial position
G13 I1.0 F30.0	Cut circle
G0 G53 Z0.0	Z axis to machine zero
M30	Program end and rewind

Example: Cut the same circle but lead-in at 45°. ($X=1*\text{Cos}(45^\circ)=.7071$, $Y=1*\text{Sin}(45^\circ)=.7071$)

G0 G90 G54 G17 G40 G49 G80	Safe start line, absolute mode, XY plane
G0 X1.5 Y.25	Move to initial position
G13 I0.7071 J0.7071 F30.0	Cut circle
G0 G53 Z0.0	Z axis to machine zero
M30	Program end and rewind

G15/G16 – Polar Coordinates: To enable polar coordinate positioning command G16 in a program. The setting is modal and will remain active until G15, polar coordinate cancel, is commanded or the system is reset. In the polar coordinate mode movement end points are specified as a radius and angle, the origin of which is determined by the absolute/incremental position mode setting (see G90/G91). In absolute position mode the origin for positioning is the zero point of the user coordinate system. In incremental position mode the origin is the current position.

Format: G16 X__ Y__ Z__

The current plane setting determines which word is radius and which is angle.

G17 – XY Plane – X is radius, Y is angle

G18 – ZX Plane – Z is radius, X is angle

G19 – YZ Plane – Y is radius, Z is angle

Linear and arc moves can be programmed in the polar coordinate mode. When programming arc moves with G02 and G03 use R to specify the arc radius.

Example: See figure 15-1 for the tool path display of the following program.

G0 G90 G54 G17 G40 G49 G80	Safe start line, absolute mode, XY plane
G16	Enable polar coordinate mode
G0 X1.0 Y45.0	Move to radius 1 and 45° from origin
G3 X1.0 Y135.0 R0.75 F60.0	Arc move of radius .75, endpoint at radius 1.0 and angle 135°
G1 X2.25 Y180.0	Linear move to radius 2.25 angle 180°
G3 X2.25 Y0 R5.0	Arc move of radius 5., endpoint at radius 2.25, angle 0
G1 X1.0 Y45.0	Linear move to radius 1.0, angle 45°
G15	Disable polar coordinate mode
G0 G53 Z0.0	Z axis to machine zero
M30	Program end and rewind

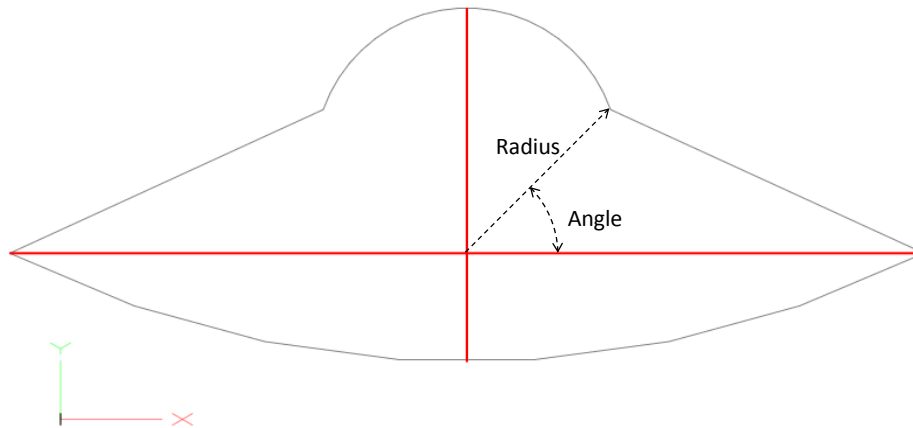

Figure 15-1: Tool path of polar coordinate mode example

G17/G18/G19 – Plane Selection: Arcs, circles and drill cycles require the selection of a plane. The three axes X, Y and Z define three available planes XY, ZX, and YZ, see figure 17-1. The third axis defines the top of the plane, this axis is also known as the normal see figure 17-2. Selection of a plane is done by specifying one of three G codes: G17 for XY, G18 for ZX and G19 for YZ. These are modal G codes and will stay active until another plane is selected or the system is reset. The default plane selection is G17.

All arc and circular motion will take place on a single plane. Direction of motion, clockwise or counterclockwise, is as viewed from the normal direction, see figure 17-2.

Canned drill cycles also require the selection of a plane. In this case all hole positions will be located in the selected plane and the normal axis will be the drilling axis. For example in the XY plane the Z axis is the drilling axis.

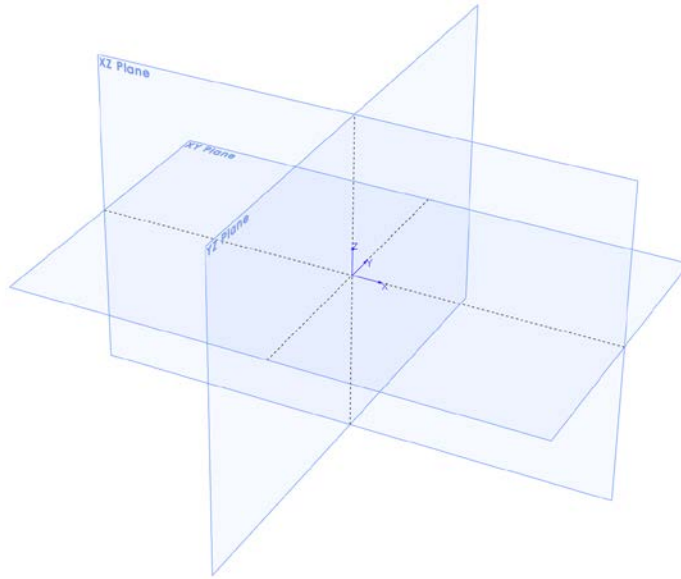

Figure 17-1: Planes

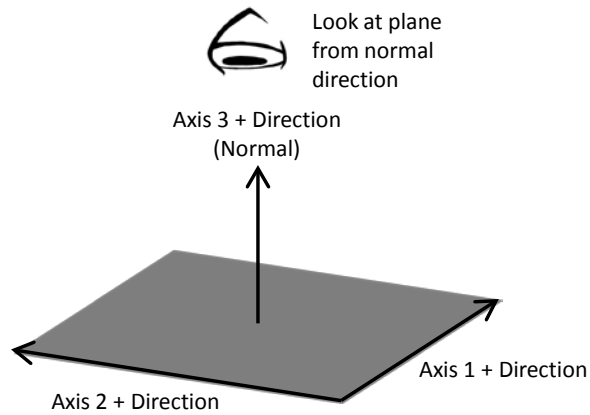

Figure 17-2: Plane orientation

G20/G21 – Unit selection: Programming units are selected using G20 for inch and G21 for millimeter. Use these G codes to specify the units in the program only; the setting will not affect Mach DRO's, configuration settings, or offsets.

G28 – Zero Return: This function is used to send one or more axes to the home position via an intermediate point. Exercise caution when using this function. If not fully understood the resulting

motion may differ greatly from what is expected. When used correctly the intermediate point can be useful for avoiding obstacles in the way of a direct path to the home position, see figure 28-1.

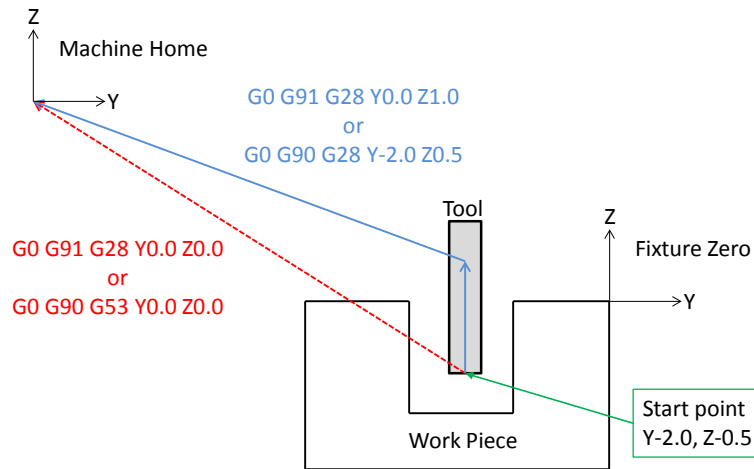

Figure 28-1: Zero return via intermediate point

Format: G28 X__ Y__ Z__ A__ B__ C__

This is not a modal code and will only be active in the block in which it is specified. Following the G28 are the axes to be sent home. For example, to send the Z axis back to the home position program: G28 Z0. The value specified with the axis letter specifies the intermediate point.

Look at an example program:

G0 G90 G54 G17 G40 G49 G80	Safe start line
G0 X1.0 Y.5 Z1.0	Rapid position to point
G28 Z0.0	Send Z axis home via point Z0
M30	Program end and rewind

Reading through the program there is a safe start up block that sets the machine to absolute position mode. The next line causes the machine to move to the point X1, Y.5, Z1. in the coordinate system set by the G54 fixture offset. Now for the G28 block. This line of code, G28 Z0, gives instructions to send the Z axis to the home position via the point Z0. The motion will be as follows: First the Z axis will plunge to the point Z0 then return to home. If not intended this motion could result in a broken tool or scrapped part. To avoid this unintended motion the common programming format is as follows:

G91 G28 Z0

In this case the intermediate point is an incremental move of 0 inches resulting in no motion before the Z axis returns home.

G30 – 2nd, 3rd, 4th Zero Return: G30 functions the same way as G28, moving the machine to a zero return point via an intermediate point. However, instead of sending the machine to the home position, G30 movement ends at a user definable 2nd, 3rd, or 4th zero return point, specified by P2, P3, or P4 respectively. If P is omitted the 2nd zero return point is selected. This is handy for tool changers that are not located at the home position or any number of other applications.

Format: G30 P__ X__ Y__ Z__ A__ B__ C__

The 2nd zero return point is defined by # variables as follows:

Axis	P2 # Variables	P3 # Variables	P4 # Variables
X	5301	5311	5321
Y	5302	5312	5322
Z	5303	5313	5323
A	5304	5314	5324
B	5305	5315	5325
C	5306	5316	5326

The position values in the # variables can be set in a program or in MDI mode.

G31/G31.X – Probe function: Also known as skip function, G31 allows the use of part and tool probes. Multiple probes can be used, G31 for probe 1, G31.1 probe 2, G31.2 probe 3 and G31.3 probe 4. Motion is defined along linear axes, in a similar format to G01, with a feedrate.

Format: G31 X__ Y__ Z__ F__

The machine will move toward the specified end point, at the same time it is looking for the probe input to be activated. When the probe input is activated the current position is recorded to # variables according to the table below and motion is stopped. The recorded position can then be used to calculate tool offsets, work offsets, measure parts, etc.

Axis	G31 # Variables	G31.1 # Variables	G31.2	G31.3
X	5061	5071		
Y	5062	5072		
Z	5063	5073		
A	5064	5074		
B	5065	5075		
C	5066	5076		

G32 – Threading: It is possible to cut threads using a spindle to rotate the work piece and a non rotating threading tool. Equal lead straight, tapered and scroll threads can be cutting using this command. Spindle speed feedback from an encoder, index pulse, tachometer or other device is required for this operation. The syncing of the feed axis to the spindle speed creates an accurate thread; however, axis

acceleration can cause variations in the thread lead especially at the start and end of the thread. The compensate program a slightly longer thread to give the axis time to accelerate. The amount of extra thread length will vary based on machine specifications. Changes in spindle speed and feedrate will impact thread quality and accuracy. Using constant surface speed mode can also result in variations in thread lead when cutting tapered or scroll threads, use G97 constant RPM mode instead. During the threading move the spindle speed and feedrate overrides will be disabled and the machine will run at 100%. Feed hold will be delayed, if pressed the machine will stop at the end of the threading move.

Format: G32 X__ Y__ Z__ F__

The G32 threading cycle is a single linear move synced to the spindle speed. F specifies the lead or pitch of the thread. For example a 20 TPI thread would have a pitch of .05 inches, so program F.05. By default the movement is basic linear move with synced feedrate. Machine builders and advanced users have the added option to create custom M codes to specify the feed vector to create custom threads.

Example: Thread a ¼-20 rod held in the spindle, 1" length of thread.

G0 G90 G54 G18 G40 G49 G80	Safe start line
G0 X0.3 Y0.0 Z0.1	Rapid position
G97 S1000 M3	Start spindle at 1000 RPM
G0 X0.22	Move to start position for rough
G32 X0.22 Z-1.0 F.05	Cut straight thread
G0 X0.3	Retract X axis
Z0.1	Retract Z axis
X0.21	Move to start position for finish
G32 X0.21 Z-1.0 F.05	Cut straight thread
G0 X0.3	Retract X axis
Z0.1	Retract Z axis
G53 Z0.0 M5	Z home and stop spindle
M30	Program end and rewind

Threads can also be cut with a taper by adding the proper end point.

Example: Cut same thread as previous example with 0.03 taper.

G0 G90 G54 G18 G40 G49 G80	Safe start line
G0 X0.3 Y0.0 Z0.1	Rapid position
G97 S1000 M3	Start spindle at 1000 RPM
G0 X0.22	Move to start position for rough
G32 X0.25 Z-1.0 F.05	Cut tapered thread
G0 X0.3	Retract X axis
Z0.1	Retract Z axis
X0.21	Move to start position for finish
G32 X0.24 Z-1.0 F.05	Cut tapered thread
G0 X0.3	Retract X axis
Z0.1	Retract Z axis

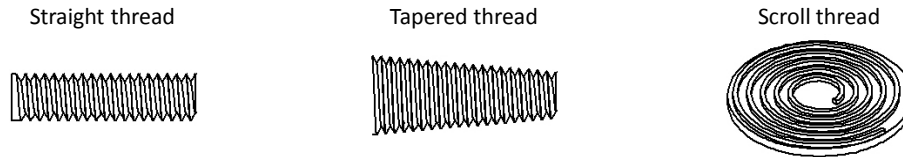

Figure 32-1: Basic thread types

G40 – Cutter Compensation Cancel: Cancels the cutter compensation mode.

G41/G42 – Cutter Compensation Left/Right: Enables cutter compensation to the left (G41) or right (G42) of the cutter path by an amount specified in an offset selected by D.

Format: G1 G42 D__ X__ Y__ Z__ F__

For detailed information see the [cutter compensation](#) section of this manual.

G43/G44 – Tool Length Offset: Activates a tool length offset selected with H. When activated the position DROs will be updated to display the position of the program point of the tool, generally the tip. The tool offset can be applied in the positive direction with G43 or in the negative direction with G44. Generally G43 will be used to apply the tool offset. There are a number of ways of touching off a tool and determining the offset value, see tool offsets in the operation manual for more details, but they are all called and applied the same way.

Format: G43 H__ X__ Y__ Z__

If axis positions are specified in the same block as G43 the machine will move to the commanded point. If the axes are omitted there will be no motion.

G49 – Tool Length Offset Cancel: Cancels the tool length offset. If no motion is commanded in the G49 block there will be no motion of the machine.

G50 – Scaling Cancel: Cancels scaling.

G51 – Scaling/Mirroring Function: When activated the scaling function multiplies all commanded positions by the specified scale factor. The DROs and offsets are not affected, but motion commanded from a program or the MDI screen is affected.

Format: G51 X__ Y__ Z__ A__ B__ C__

Specify the axis to be scaled and the desired scale factor. For example:

G0 G90 G54 G17 G40 G49 G80	Safe start line
G0 X4.0 Y0.0 Z1.0	Rapid position to point (X position is 4.)
G51 X2.0	Activate scaling on X axis (scale factor = 2)
G0 X5.0	Rapid position to point (X position is 10.)
G50	Cancel Scaling
G0 X5.0	Rapid position to point (X position is 5.)
M30	Program end and rewind

When scaling is active position moves will be calculated by multiplying the commanded position by the scale factor. In the example above the scale factor on the X axis is set to 2, then a move to X5. is commanded. The actual end position of this move will be $5 * 2 = 10$. So the X axis moves to 10.

Exercise caution when using scaling, the results can be unpredictable depending on program complexity. For example if G52 X2 Y4 is programmed followed by an arc move in the XY plane, the arc will NOT be scaled 2x in the X axis and 4x in the Y axis to obtain an ellipse. The start and end positions will be as expected, but the motion from one to the other may not be. Check and double check the tool path display before running the program.

To mirror a program, enter a negative scale value. For example:

G0 G90 G54 G17 G40 G49 G80	Safe start line
G0 X4.0 Y0.0 Z1.0	Rapid position to point (X position is 4.)
G51 X-1.0	Mirror X axis (scale factor = 1)
G0 X5.0	Rapid position to point (X position is -5.)
G50	Cancel Scaling
G0 X5.0	Rapid position to point (X position is 5.)
M30	Program end and rewind

G52 – Local Coordinate System Shift: The local coordinate system setting is a programmable work shift. The setting is global; the entire system is shifted by the specified values. Every fixture offset will be affected, although the actual fixture offset values will not be changed.

Format: G52 X__ Y__ Z__ A__ B__ C__

To activate a local coordinate system with G52 use the above format. Setting of a local coordinate system is just like setting a fixture offset. In the G52 block specify the desired axes to set, and the value of the shift. For example (see figure 52-1 for the tool path):

G0 G90 G54 G17 G40 G49 G80	Safe start line
G0 X-4.0 Y0.0 Z1.0	Rapid position to point
G12 I2.0 F30.0	Cut circle with radius 2.0
G52 X7.0	Local Coordinate system active, X offset = 7
G0 X-4.0 Y0.0 Z1.0	Rapid to same start point
G12 I2.0 F30.0	Cut same circle with radius 2.0
G52 X0.0	Local coordinate system cancelled
M30	Program end and rewind

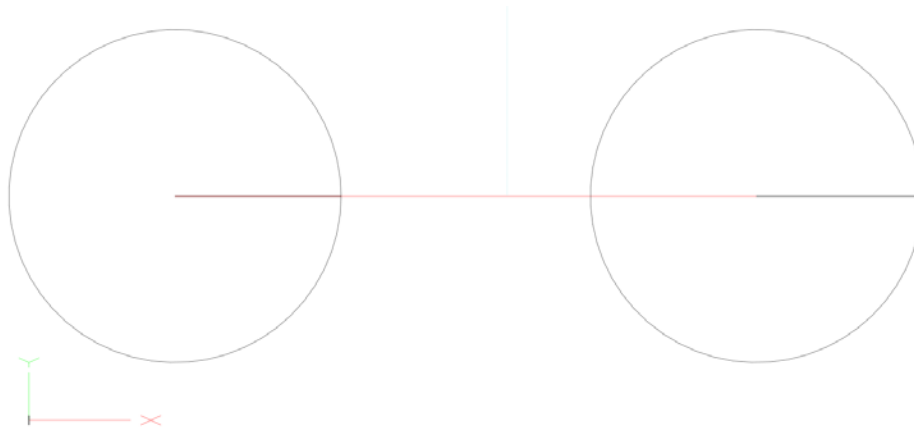

Figure 52-1: Example program tool path.

Once set, the setting will remain until cancelled by another G52 or the system is reset. As in the example above, a local coordinate system can be cancelled by specifying the axis with a value of zero. This effectively sets the local coordinate system shift to zero, giving it no effect.

G53 – Machine Coordinate System: Although the majority of machine positioning will take place in a user created coordinate system it is sometimes beneficial to program positions in the machine coordinate system. G53 is a non modal, only active for the block in which it is specified, G code that allows the user to make positioning moves in the machine coordinate system. This can be useful for moving to a load/unload position at the end of a program or moving to a tool change location in a tool change macro. This is also a much safer way to move back to the machine home position, G53 X0 Y0 Z0, than using G28 as there is no intermediate position to be concerned with.

Format: G53 X__ Y__ Z__ A__ B__ C__

G0 G90 G54 G17 G40 G49 G80	Safe start line
G0 X4.0 Y0.0 Z1.0	Rapid position in G54
...	Body of program
G53 Z0.0	Return directly to Z home position
G53 X10.0 Y0.0	Move to load/unload position
M30	Program end and rewind

In the example above, the last two positioning moves are made in the machine coordinate system. These two blocks could be the same for every program in this machine.

G54-G59 – Fixture Offset: Used to select the active fixture offset in a program. The fixture offset will stay active until another is called or the system is reset. It is possible to use multiple fixture offsets in a single program.

G54.1 – Additional Fixture Offsets: Additional fixture offsets are provided for users with many fixtures/parts/ setups. There are 248 additional offsets available.

Format: G54.1 P__

P specifies the number of the additional offset, 1 thru 248.

Previous version of Mach use G59 P7, P8 and so on. These legacy offsets can still be used in place of the G54.1. G59 P7 = G54.1 P1, G59 P8 = G54.1 P2, and so on. G54.1 is more consistent with industry machines.

Please see the fixture offset section of this manual for more detail on setting up fixture offsets.

G60 – Unidirectional Approach: In cases where mechanical backlash causes positioning errors unidirectional approach can be used to increase accuracy. G60 is a non-modal code, when specified in a movement block motion will move to the end point from a parameter defined distance and direction, see figure 60-1. The distance and direction of the approach movement is specified by setting values in # variables as shown in the following table:

Axis	# Variable
X	5440
Y	5441
Z	5442
A	5443
B	5444
C	5445

Format: G60 G0/G1 X__ Y__ Z__

When unidirectional approach is used in a drill cycle the Z axis motion is not affected. G76 and G87 boring cycles have a tool shift that is also not affected by the G60 unidirectional approach.

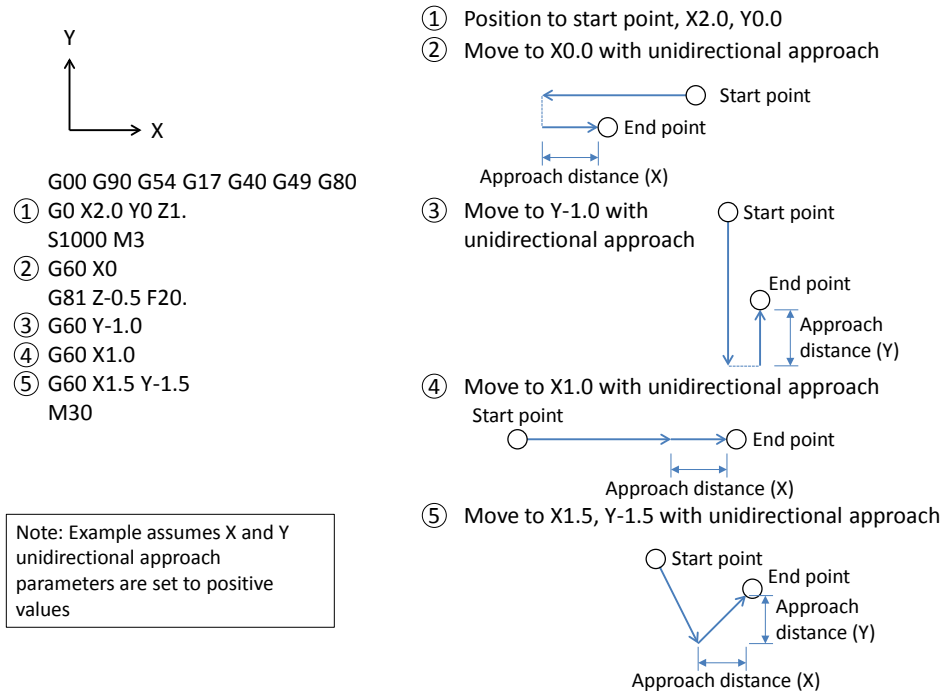

Figure 60-1: Unidirectional approach.

G61 – Exact Stop Mode: In exact stop mode the machine will decelerate to a complete stop at the end of each commanded move, see figure 9-1. This is a modal code, once activated it will remain on until canceled. For sharp corners and simple positioning this mode works well. However, when the code gets more complex, or in side milling with arcs, the exact stop mode will produce jerky motion and witness marks on the work piece. For most milling jobs use G64.

G64 – Constant Velocity Mode: In constant velocity mode Mach will try to maintain feedrate even around sharp corners. As a result sharp corners will be slightly rounded and the machine may never reach the programmed point before a direction change. The magnitude of these position errors will be determined by the acceleration capability of the machine and the programmed feedrate. In most cases the error will be too small to notice or affect part function. Cutting will be faster and smoother with better finishes and no witness marks from stopping. This will be the active mode for the majority of machining time. It is modal and will be active until exact stop mode is activated.

G65 – Macro Call: Macros work like subprograms (see M98 on page 57) but allow values to be passed from the main program in the form of local variables. Macro programs can use these local variables passed to it to change part dimensions, select features, adjust feedrates, or anything else the user could need to change.

Format: G65 P____ A__ B__ C__ ...

The desired program number to be called is specified by P. The remaining arguments are determined by the macro program being called. The values of these arguments will be passed to local variables for use in the macro program. The available arguments and corresponding variables are shown in the table below.

Address	Variable	Address	Variable	Address	Variable
A	#1	I	#4	T	#20
B	#2	J	#5	U	#21
C	#3	K	#6	V	#22
D	#7	M	#13	W	#23
E	#8	Q	#17	X	#24
F	#9	R	#18	Y	#25
H	#11	S	#19	Z	#26

The G65 macro call is non modal and has no option for repeating, the macro subprogram will be run only once per G65 call. For more information on macro programming and the availability and use of # variables see the Mach4 Macro Programming Guide.

G66 – Macro Modal Call: Sometimes it is useful to run the same macro in different positions (similar to drilling canned cycles) or with different parameters. G66 is a modal macro call, the macro is called and values passed in the same way as G65, but G66 remains active until cancelled. The block(s) following the G66 can contain new positions and variables to run the macro again.

Format: G66 P___ A__ B__ C__ ...
A__ B__ C__ ...
G67

More information on macro programming is available in the Mach4 Macro Programming Guide.

G67 – Macro Modal Call Cancel: Cancels the macro modal call.

G68 – Coordinate System Rotation: It is possible to rotate a program around a specified point using the coordinate system rotation command. It is specified as follows:

Format: G68 X__ Y__ R__

The command is only available in the XY (G17) plane and is modal. X and Y specify the point around which the program will be rotated, and R specifies the angle. A positive value for R will rotate the program counter clockwise when looking at the plane from the positive direction.

Once the rotation command is given, all command moves will take place in this rotated system. In effect, the X and Y axes of the machine will rotate the amount specified by R.

G0 G90 G54 G17 G40 G49 G80	Safe start line
G0 X0.0 Y0.0 Z1.0	Rapid position to point
G68 X0.0 Y0.0 R45.0	Rotate 45° counter clockwise about X0, Y0
G0 X1.0	Rapid position to X1.
G69	Cancel rotation
M30	Program end and rewind

In the example above, the machine will move to X0, Y0 then initiate the coordinate rotation of 45°. The next move is a purely X axis move to X1. However, because the coordinate system has been rotated the current X axis is actually 45° from the machine actual X axis. When the move takes place both X and Y axes will move to the programmed point. In this case the DROs will read X.7071 and Y.7071. See figure 68-1.

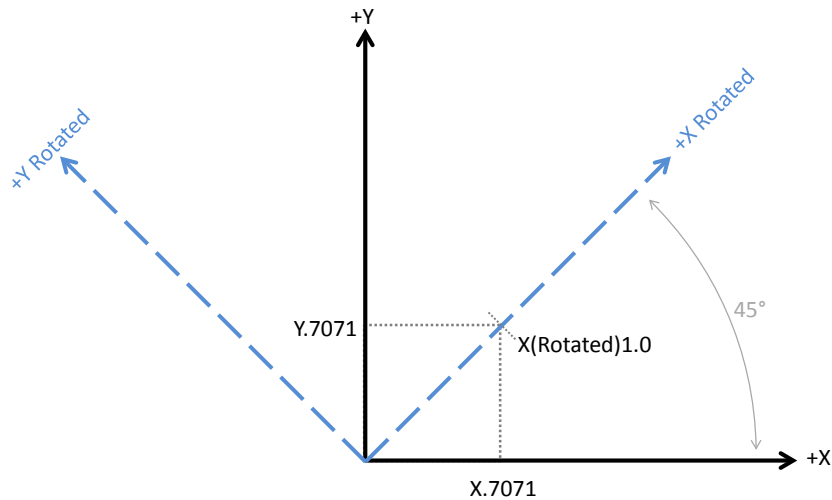

Figure 68-1: Coordinate system rotation (G68 X0 Y0 R45)

The coordinates X.7071 and Y.7071 can be proven using simple geometry or trigonometry functions.

Coordinate system rotation is useful in many applications. Combined with a part probe the function can provide a lot of power and accuracy. When probing a part to find its location, it is also possible to determine if the part is clamped square to the axes or if it is oriented at some angle. If the part is skewed at an angle it can be automatically compensated for, resulting in higher quality parts.

G69 – Coordinate System Rotation Cancel: Cancels a coordinate system rotation command. The machine returns back to normal function.

G73-G89 – Canned Cycles: Canned cycles are special G codes used to simplify programming. See the [Canned Cycles](#) section of this manual for detailed information.

G73	High Speed Peck	G73 X_Y_Z_R_Q_F_
G74	Reverse Tapping	G74 X_Y_Z_R_F_
G76	Fine Boring	G76 X_Y_Z_R_I_J_P_F_
G80	Canned Cycle Cancel	G80
G81	Drilling	G81 X_Y_Z_R_F_
G82	Spot Face	G82 X_Y_Z_R_P_F_
G83	Deep Hole Peck Drilling	G83 X_Y_Z_R_Q_F_

G84	Tapping	G84 X_Y_Z_R_F_
G85	Boring, Retract at Feed, Spindle On	G85 X_Y_Z_R_F_
G86	Boring, Retract at Rapid, Spindle Off	G86 X_Y_Z_R_F_
G87	Back Boring	G87 X_Y_Z_R_I_J_F_
G88	Boring, Manual Retract	G88 X_Y_Z_R_P_F_
G89	Boring, Dwell, Retract at Feed, Spindle On	G89 X_Y_Z_R_P_F_

G90/G91 – Absolute/Incremental Position Mode: In absolute position mode, the machine will move to the commanded position in the active user coordinate system.

Example: Write a program to move to the hole positions in figure 90-1 in absolute position mode. Assume the machine starts at position X0, Y0, end the program at X0, Y0.

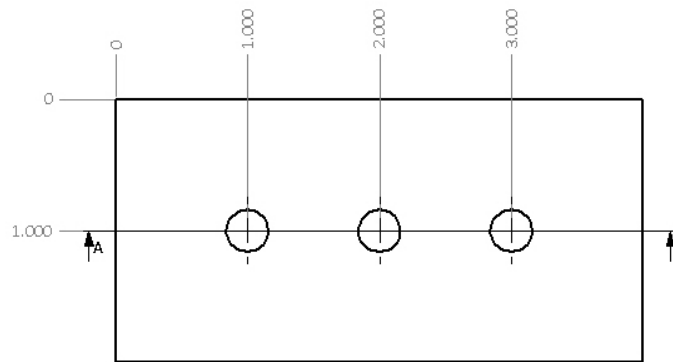

Figure 90-1: Hole pattern example

G0 G90 G54 G17 G40 G49 G80	Safe start line
G90	Absolute position mode
G0 X1.0 Y-1.0	Rapid to 1 st hole
X2.0	Rapid to 2 nd hole
X3.0	Rapid to 3 rd hole
X0.0 Y0.0	Rapid back to 0, 0
M30	Program end and rewind

In incremental position mode, commanded moves are interpreted as distance and direction from the current position. A command of X1 will move 1 in the positive direction, NOT necessarily to the point X1 in the user coordinate system.

Example: Write a program to move to the hole positions in figure 90-1 in incremental position mode. Assume the machine starts at position X0, Y0, end the program at X0, Y0.

G0 G90 G54 G17 G40 G49 G80	Safe start line
G91	Incremental position mode
G0 X1.0 Y-1.0	Rapid to 1 st hole
X1.0	Rapid to 2 nd hole
X1.0	Rapid to 3 rd hole

X-3.0 Y1.0	Rapid back to 0, 0
M30	Program end and rewind

Compare this to the program from G90. Because the starting point is X0, Y0 in both examples the move to the 1st hole is the same. However, if the machine started at X1, Y1 the absolute position program would still be correct, the incremental program would be shifted by the start location. For this reason it is important to ensure the proper mode is enabled for the program in use. A good safe start line will always contain a G90 or G91. These G codes are modal and will stay active until the other is specified.

G90.1/G91.1 – Absolute/Incremental Arc Center Mode: This setting affects arcs when programmed in the I, J, K format. In absolute arc center mode the I, J, K values designate the position of the arc center in the user coordinate system. In incremental arc center mode the I, J, K values designate the distance and direction to the arc center from the start point. See figure 2-1 for a graphical description.

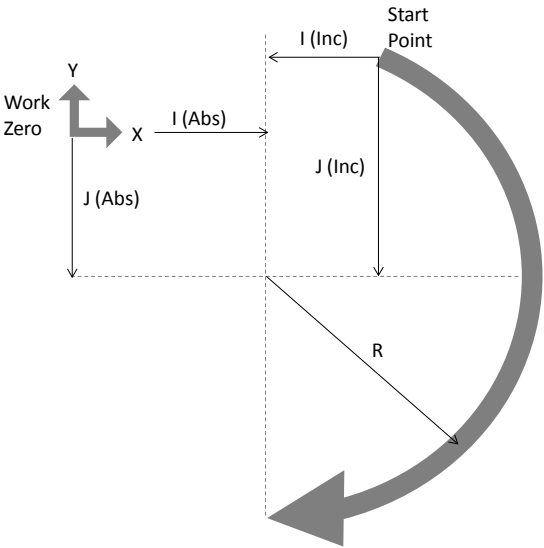

Figure 2-1: Path of tool point in circular and helical interpolation (G02).

Example: Program an arc centered at 1.0, 0.0 in the XY plane with radius 2. Start point at 3.0,0.0 and sweep 90 degrees counter clockwise. Program two times, once in incremental arc center mode and once in absolute arc center mode.

G0 G90 G54 G17 G40 G49 G80	Safe start line
G91.1	Incremental arc center mode
T1 M6	Tool change
S2500 M3	Start spindle
G0 X3.0 Y0.0	Position to X and Y start point
G43 H1 Z.5	Activate tool offset 1 and move to Z rapid plane
G1 Z0.0 F10.0	Z plunge at feedrate

G3 X1.0 Y2.0 I-2.0 J0.0 F10.0	Arc move
G0 Z.5	Retract Z to rapid plane
G0 G53 Z0.0	Return Z to home
M30	Program end and rewind

G0 G90 G54 G17 G40 G49 G80	Safe start line
G90.1	Absolute arc center mode
T1 M6	Tool change
S2500 M3	Start spindle
G0 X3.0 Y0.0	Position to X and Y start point
G43 H1 Z.5	Activate tool offset 1 and move to Z rapid plane
G1 Z0.0 F10.0	Z plunge at feedrate
G3 X1.0 Y2.0 I1.0 J0.0 F10.0	Arc move
G0 Z.5	Retract Z to rapid plane
G0 G53 Z0.0	Return Z to home
M30	Program end and rewind

Notice the difference in the I values of the example programs. Both programs will produce the same arc.

G92 – Local Coordinate System Setting: The coordinate system can be set by issuing G92 in the program. This function differs from G52 (Local Coordinate System Shift) in the way that it is specified. While G52 is specified with shift values, G92 is specified with the desired axis position. The affect is global and should be used with caution.

Format: G92 X__ Y__ Z__ A__ B__ C__

Using the above format specify a value for the desired axis. When G92 is specified the position DRO's are updated to the values specified. The local coordinate system setting will be cancelled when a G92.1 is specified or the system is reset.

G0 G90 G54 G17 G40 G49 G80	Safe start line
G0 X4.0 Y0.0 Z1.0	Rapid move, current position X4, Y0, Z1
G92 X1.0 Y2.0 Z3.0	Set local coordinate system, current position X1, Y2, Z3
G92.1	Cancel local coordinate system, current position X4, Y0, Z1
M30	Program end and rewind

G92 was used for fixture offset setting before fixture offsets were available. It is recommended that the fixture offsets be used instead of using G92. The offset amount of the G92 setting is not immediately known by the user, because of this the results can be unpredictable when fixture offsets and G92 are combined.

G93 – Inverse Time Feed: Inverse time feed is most commonly used for machine movement containing at least one rotary axis, however that is not the only application. Instead of specifying a velocity a time to complete the movement is specified. The following formula is used to determine F:

$$F = \frac{1}{\text{time (min)}} = \frac{\text{feedrate (units/min)}}{\text{distance (units)}}$$

When inverse time feed is active an F word is required in every block of code containing a feed move.

G94 – Feed Per Minute: Most common feedrate setting. Specify the desired feedrate in units/minute. In this mode the feedrate is modal and not required in all feed move blocks.

G95 – Feed Per Revolution: In mills the feed per revolution setting is most commonly used for tapping cycles. In this mode the feed rate is specified in units/revolution of the spindle. In the case of tapping the feedrate can be set as the pitch of the tap. For every revolution of the spindle the machine will move the specified units. Feed per rev mode requires RPM feedback from the spindle.

G96 – Constant Surface Speed: Spindle speed can be specified two ways. One is constant surface speed. In this mode Mach will try to keep the surface speed constant based on cutting diameter. Surface speed is specified in surface units per minute. In the inch mode this is surface feet per minute, in millimeter mode it is surface meters per minute.

G97 – Constant RPM: In this mode the spindle speed is specified in revolutions per minute. This is the most common setting for milling machines.

G98 – Initial Point Return: Specifies that a canned cycle end at the initial Z level. The machine will also return to the initial point before a rapid move to the next position. Initial point return is useful for avoiding steps in parts or fixture clamps without adding a significant amount of cycle time. See figure 98-1.

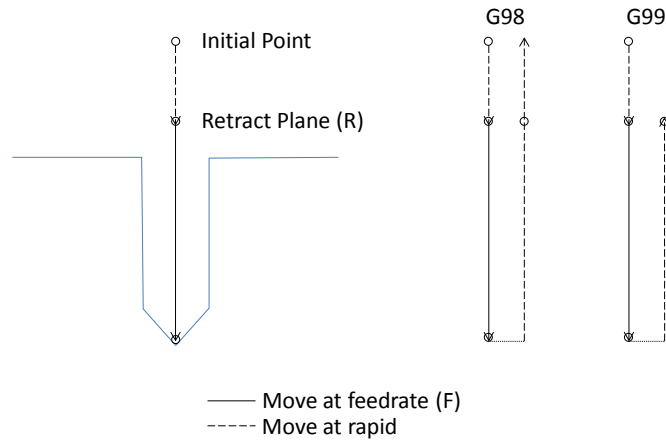

Figure 98-1: Initial and R point return setting.

G99 – R Point Return: Specifies that a canned cycle end at the programmed R level, see figure 98-1. When drilling holes in a flat plate, G99 can be used to reduce excessive machine movement decreasing cycle time.

Chapter 3: Canned Cycles

G73	High Speed Peck	G73 X_Y_Z_R_Q_F_
G74	Reverse Tapping	G74 X_Y_Z_R_F_
G76	Fine Boring	G76 X_Y_Z_R_I_J_P_F_
G80	Canned Cycle Cancel	G80
G81	Drilling	G81 X_Y_Z_R_F_
G82	Spot Face	G82 X_Y_Z_R_P_F_
G83	Deep Hole Peck Drilling	G83 X_Y_Z_R_Q_F_
G84	Tapping	G84 X_Y_Z_R_F_
G85	Boring, Retract at Feed, Spindle On	G85 X_Y_Z_R_F_
G86	Boring, Retract at Rapid, Spindle Off	G86 X_Y_Z_R_F_
G87	Back Boring	G87 X_Y_Z_R_I_J_F_
G88	Boring, Manual Retract	G88 X_Y_Z_R_P_F_
G89	Boring, Dwell, Retract at Feed, Spindle On	G89 X_Y_Z_R_P_F_

Canned cycles are used to reduce program complexity. For example peck drilling a 1 inch hole with .1 inch peck depth would use 30 lines of regular code, but with a canned cycle this same hole can be completed in just 2 lines of code. More importantly if multiple holes are required only 1 extra line of

code per hole is needed. There are a variety of canned cycles for different hole types including drilling, boring, and tapping.

Hole machining cycles all behave similarly and mostly contain the same parameters. The meaning of each parameter can change depending on two settings. The first is the absolute or incremental mode setting (G90/G91) as defined earlier in this manual. The second is the return point selection G98 initial point return or G99 R point return.

Plane selection (G17/G18/G19) can also have an effect on hole machining cycles. Positioning will take place in the active plane, and the drilling operation will be on the normal axis. For example in G17 (XY Plane) hole position will be on the XY plane and the drilling axis will be Z. In G18 (ZX Plane) positioning will be on the ZX plane and the drilling axis will be Y. For the purposes of this manual all examples and definitions will be in the XY plane (G17).

The basic format of a canned cycle is as follows:

Gcc G98/99 Xxx Yyy Zzz Qqq Rrr Ppp Lll Fff
Xxn Yyn
G80

cc	Number of the desired canned cycle (i.e. 81, 83, 74, etc)
xx	In G90: X position of the center point of the first hole with respect to the current work zero point
	In G91: Distance and direction along X axis to center point of first hole from the current position
yy	In G90: Y position of the center point of the first hole with respect to the current work zero point
	In G91: Distance and direction along Y axis to center point of first hole from the current position
zz	In G90: Z position of bottom of hole with respect to the current work zero point
	In G91: Distance and direction along Z axis, from point R, to bottom of hole
qq	Peck increment if deep hole drilling, always positive
rr	Retract plane, retract position between pecks, in G99 mode this is the rapid plane
pp	Dwell, in seconds, at bottom of hole
ll	Number of repetitions
ff	Feedrate
xn	Position of nth hole X axis, same rules as applied to xx
yn	Position of nth hole Y axis, same rules as applied to yy

Please note that not all arguments will appear in all cycles, and there are a couple special cases that will be discussed.

Figure 2: Example hole pattern

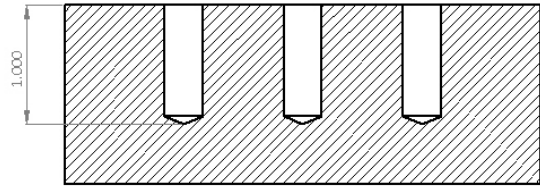
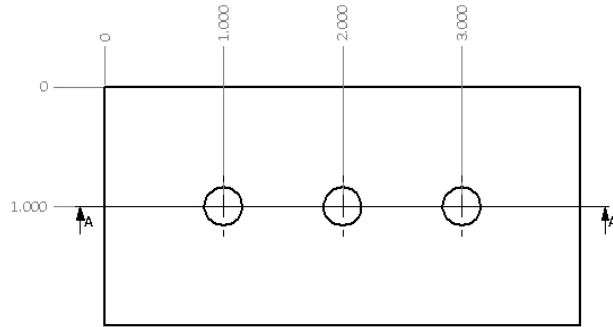

SECTION A-A

G80 – Canned Cycle Cancel: To end a canned cycle a G80 must be called. G80 should be specified on its own line to avoid any unintended movements. For example:

G0 G90 G54 G17 G40 G49 G80	Safe start line
T1 M6	Tool change
S2500 M3	Start spindle
G0 X1.0 Y-1.0	Position to X and Y start point
G43 H1 Z.5	Activate tool offset 1 and move to Z initial point
G81 G99 X1.0 Y-1.0 Z-1.0 R.25 F10	Drill cycle start
X2.0 Y-1.0	Drill second hole
X3.0 Y-1.0	Drill third hole
G80	Canned cycle cancel
G0 G53 Z0	Return Z to home
M30	Program end and rewind

Drilling

G81 – Drilling: This is a straight drilling cycle. The tool simply moves to position, feeds to the bottom of the hole then rapid retracts to either the R point or the initial point. See figure 81-1 for a graphic of the tool motion. The format is as follows:

G81 X__ Y__ Z__ R__ L__ F__

X, Y – Position of hole in XY plane

Z – End point of hole

R – Retract plane

L – Number of repetitions

F – Feedrate

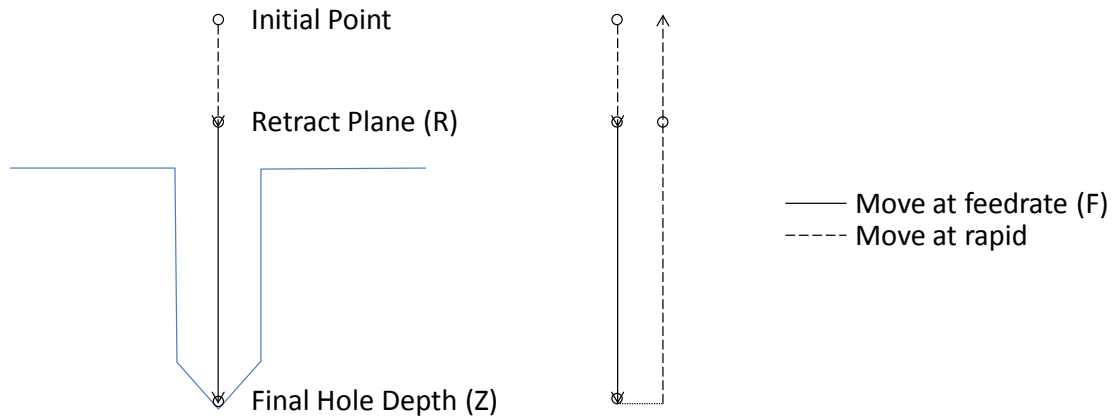

Figure 81-1: Motion of tool point for G81 cycle. End Z position will be determined by G98/99 setting.

Example:

Create the program for the holes shown in Figure igure 2.

G0 G90 G54 G17 G40 G49 G80	Safe start line
T1 M6	Tool change
S2500 M3	Start spindle
G0 X1.0 Y-1.0	Position to X and Y start point
G43 H1 Z.5	Activate tool offset 1 and move to Z initial point
G81 G99 X1.0 Y-1.0 Z-1.0 R.25 F10	Drill cycle start
X2.0 Y-1.0	Drill second hole
X3.0 Y-1.0	Drill third hole
G80	Canned cycle cancel
G0 G53 Z0	Return Z to home
M30	Program end and rewind

G82 – Spot Face: Spot face adds the ability to dwell at the bottom of the hole for a specified amount of time. The actual tool motion is the same as a G81 cycle, however with the dwell it is possible to attain better accuracy and finish at the bottom of the hole. This is useful for chamfering, counter boring, and spot facing. The format is as follows:

G82 X__ Y__ Z__ R__ P__ L__ F__

X, Y – Position of hole in XY plane

Z – End point of hole

R – Retract plane

P – Dwell

L – Number of repetitions

F – Feedrate

Example:

Create a chamfering program for the holes shown in figure 2, dwell for .2 seconds.

G0 G90 G54 G17 G40 G49 G80	Safe start line
T1 M6	Tool change
S2500 M3	Start spindle
G0 X1.0 Y-1.0	Position to X and Y start point
G43 H1 Z.5	Activate tool offset 1 and move to Z initial point
G82 G99 X1.0 Y-1.0 Z-.200 P.2 R.25 F10	Spot drill cycle start
X2.0 Y-1.0	Drill second hole
X3.0 Y-1.0	Drill third hole
G80	Canned cycle cancel
G0 G53 Z0	Return Z to home
M30	Program end and rewind

G83 – Peck Drilling: Peck drilling is a cycle used for drilling deep holes. The cycle allows for breaking and clearing of chips and better application of coolant by fully retracting the tool from the hole between pecks. This retract move and plunge to previous depth are rapid moves, each peck is a feed move at the specified feed rate. See figure 83-1 for a graphic of the tool motion. The format is as follows:

G83 X__ Y__ Z__ Q__ R__ L__ F__

X, Y – Position of hole in XY plane

Z – End point of hole

Q – Peck amount

R – Retract plane

L – Number of repetitions

F – Feedrate

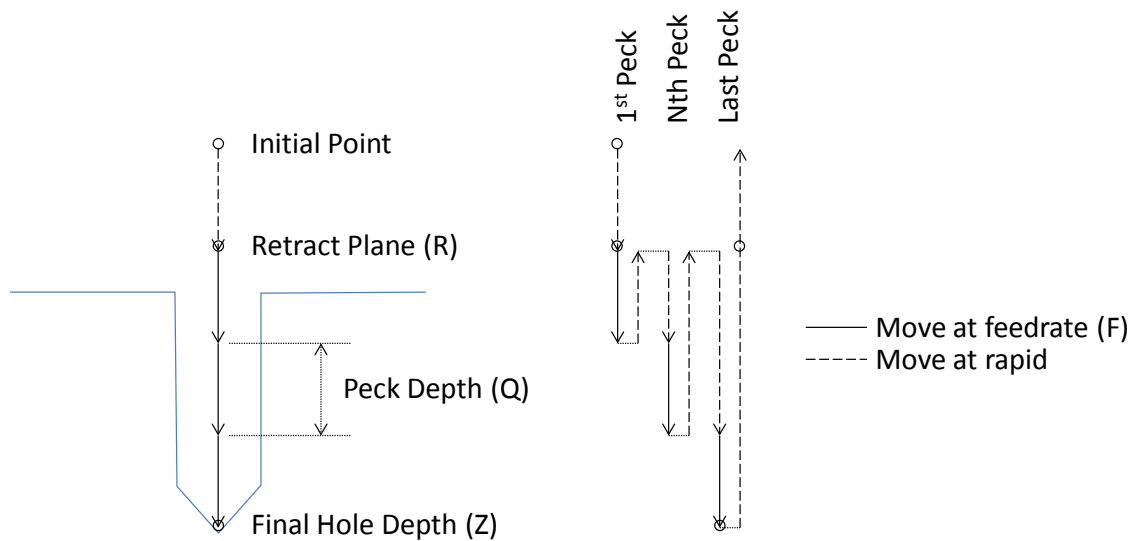

Figure 83-1: Motion of tool point for G83 cycle. End Z position will be determined by G98/99 setting.

Example:

Create the program for the holes shown in figure 2 using a .1 peck depth.

G0 G90 G54 G17 G40 G49 G80	Safe start line
T1 M6	Tool change

S2500 M3	Start spindle
G0 X1.0 Y-1.0	Position to X and Y start point
G43 H1 Z.5	Activate tool offset 1 and move to Z initial point
G83 G99 X1.0 Y-1.0 Z-1.0 Q.1 R.25 F10	Peck drill cycle start
X2.0 Y-1.0	Drill second hole
X3.0 Y-1.0	Drill third hole
G80	Canned cycle cancel
G0 G53 Z0	Return Z to home
M30	Program end and rewind

G73 – High Speed Peck: In materials that produce long stringy chips a high speed peck cycle can be used to break them up. Unlike the G83 cycle that retracts completely out of the hole after each peck, the G73 cycle only retracts .100 inch. See figure 73-1. This short retract helps to reduce cycle times when a complete retract is unnecessary. The format:

G73 X__ Y__ Z__ Q__ R__ L__ F__

X, Y – Position of hole in XY plane

Z – End point of hole

Q – Peck amount

R – Retract plane

L – Number of repetitions

F – Feedrate

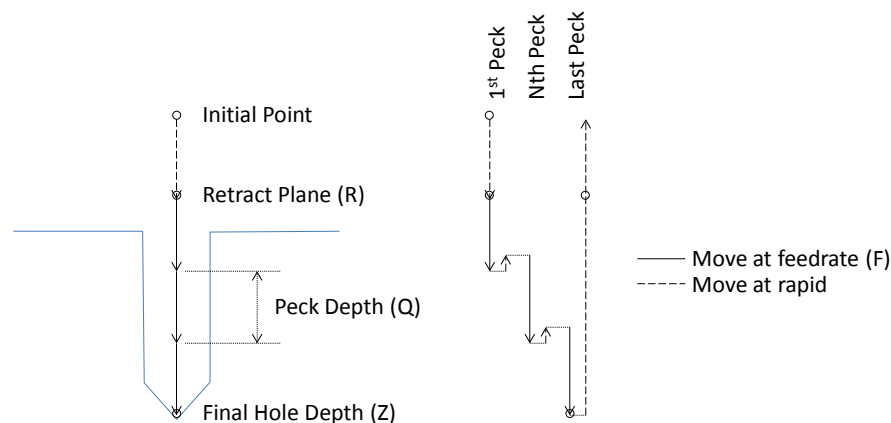

Figure 73-1: Motion of tool point for G73 cycle. End Z position will be determined by G98/99 setting.

Example:

Create the program for the holes shown in figure 2 using a .025 peck depth.

G0 G90 G54 G17 G40 G49 G80	Safe start line
T1 M6	Tool change
S2500 M3	Start spindle
G0 X1.0 Y-1.0	Position to X and Y start point
G43 H1 Z.5	Activate tool offset 1 and move to Z initial point
G73 G99 X1.0 Y-1.0 Z-1.0 Q.1 R.25 F10	Peck drill cycle start
X2.0 Y-1.0	Drill second hole
X3.0 Y-1.0	Drill third hole
G80	Canned cycle cancel
G0 G53 Z0	Return Z to home
M30	Program end and rewind

Tapping

G84 – Right Hand Tapping: The tapping cycle is used to create threaded holes using a tap. Tapping requires that the spindle rpm and Z axis feedrate be matched, related by the pitch of the thread being cut. There are two ways to achieve this synchronization of spindle speed and Z axis feedrate. From the programming side it is easier to program the feedrate in units per revolution (G95). In the feed per rev mode the commanded feedrate will be simply the pitch of the thread. Metric threads are classified with the thread pitch, i.e. M8x1.25mm thread has a 1.25mm pitch. Unified threads are classified by threads per inch which requires a bit of calculation to get the pitch, don't worry it's easy. Simply divide 1 inch by the TPI. For a ¼-20 fastener we would calculate $1/20 = .05$, this is the pitch. The catch is, to use feed per rev requires some form of rpm feedback from the machine, not every machine will have this. For the machines without feedback the tapping cycle can be programmed in feed per min mode (G94). This method requires a little more math to obtain the correct feedrate based on spindle rpm and pitch of the thread. The equation looks like this: $RPM * Pitch = IPM$. To tap that ¼-20 hole at 1500 RPM we first need to calculate the pitch, remember $1/TPI = Pitch$, so $1/20 = .05$. Now we calculate the feed per min as $1500 * .05 = 75 IPM$. It is important to note that if the spindle speed is changed, the feed per minute must also be changed to match. Now that the math is done, check out the format of the code:

```
G84 X__ Y__ Z__ R__ L__ F__
```

X, Y – Position of hole in XY plane
 Z – End point of hole
 R – Retract plane
 L – Number of repetitions
 F – Feedrate

The motion of the tapping cycle is straight forward, but does require some additional description. See Figure 84-1 for a graphic of the tool motion. The movement is very similar to a straight drill cycle, action of the spindle being the major difference. The spindle must be started in the forward direction prior to calling the G84 cycle. The machine will then move to the hole position then the Z axis will move down to the R plane. The Z will feed down to the specified depth then the spindle and Z axis will stop then reverse direction to retract out of the hole. Due to slight variations of spindle speed, feedrate and

accelerations in some machines it is recommended that a special tapping head be used. A tapping head allows the tap to float a little bit, compensating for those variations, especially at the bottom of the hole.

Changes to feedrate or spindle speed mid cycle can be damaging to the tool and work piece, for this reason the feedrate and spindle speed overrides are disabled. The machine will run at 100% override for the duration of the cycle. Feed hold is also disabled during the cycle. If feed hold is pressed motion will stop at the end of the tapping cycle.

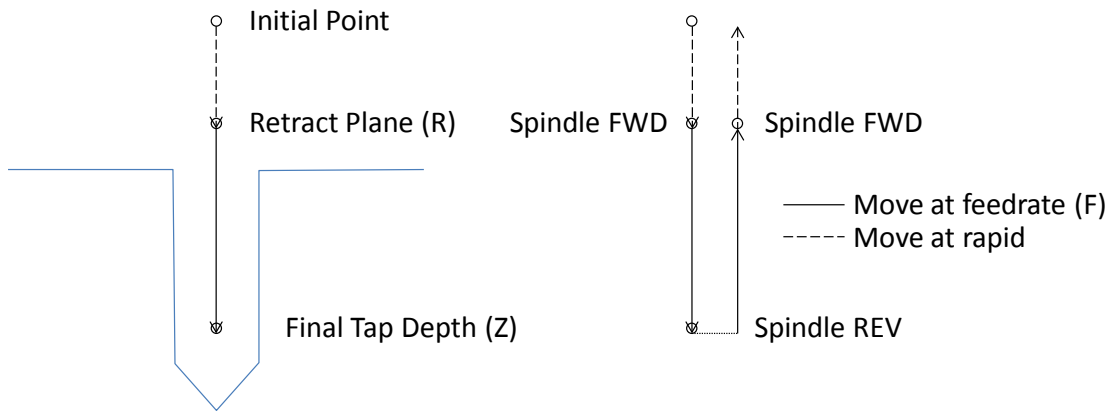

Figure 84-1: Motion of tool point for G84 cycle. End Z position will be determined by G98/99 setting.

Example:

Create the program to tap the holes shown in figure 2 to a depth of .500 with a 3/8-16 tap using feed/min.

1/16=.0625
 1000*.0625=62.5

G0 G90 G54 G17 G40 G49 G80	Safe start line
T1 M6	Tool change
S1000 M3	Start spindle
G0 X1.0 Y-1.0	Position to X and Y start point
G43 H1 Z.5	Activate tool offset 1 and move to Z initial point

G84 G99 X1.0 Y-1.0 Z-.500 R.25 F62.5	Tapping cycle start
X2.0 Y-1.0	Tap second hole
X3.0 Y-1.0	Tap third hole
G80	Canned cycle cancel
G0 G53 Z0	Return Z to home
M30	Program end and rewind

G74 – Left Hand Tapping: Left hand tapping is the same as right hand tapping (G84) except that it will cut left hand threads. The spindle must be started in the reverse direction before calling the G74 cycle.

G84.2/G84.3 – Right and Left Hand Rigid Tapping: Rigid tapping can be performed on capable machines. As the name implies the tap is held rigidly in the spindle, no tension/compression style tapping holder is required. Holding the tap in this manner requires the machine to have precise control of spindle speed, axis feed, and precise feedback of spindle RPM. The tapping axis will be electronically geared to the spindle RPM. Use G84.2 for right hand tapping and G84.3 for left hand tapping. See figure 84-1 for a graphic of the motion.

Format: G84.2/84.3 X__ Y__ Z__ R__ P__ L__ F__ J__

X, Y – Position of hole in XY plane

Z – End point of hole

R – Retract plane

P – Dwell in seconds

L – Number of repetitions

F – Feedrate

J – Spindle speed for retract

As with other tapping cycles the feedrate and spindle speed overrides are disabled and set to 100% for the duration of the cycle. Feed hold is also not effective until the end of the tapping cycle.

Example:

Create the program to tap the holes shown in figure 2 to a depth of .500 with a 3/8-16 tap using feed/min. Tap at 1000 RPM, retract at 2000 RPM

$1/16 = .0625$

$1000 * .0625 = 62.5$

G0 G90 G54 G17 G40 G49 G80	Safe start line
T1 M6	Tool change
S1000 M3	Start spindle
G0 X1.0 Y-1.0	Position to X and Y start point
G43 H1 Z.5	Activate tool offset 1 and move to Z initial point
G84.2 G99 X1.0 Y-1.0 Z-.500 R.25 F62.5 J2000	Rigid tapping cycle start
X2.0 Y-1.0	Tap second hole
X3.0 Y-1.0	Tap third hole
G80	Canned cycle cancel

G0 G53 Z0
M30

Return Z to home
Program end and rewind

Boring

G76 – Fine Boring: The fine boring cycle allows the user to stop the spindle and move the tool away from the wall before retracting. This allows for a rapid retract without leaving a scratch on the wall.

G76 X__ Y__ Z__ R__ I__ J__ P__ L__ F__

X, Y – Position of hole in XY plane

Z – End point of hole

R – Retract plane

I – X shift distance and direction

J – Y shift distance and direction

P – Dwell in seconds

L – Number of repetitions

F – Feedrate

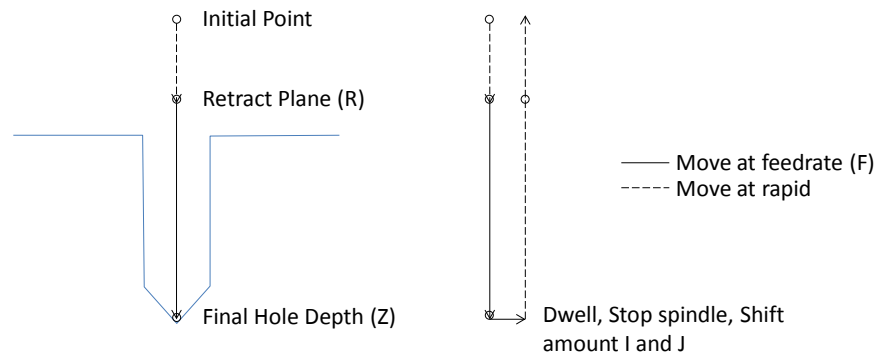

Figure 76-1: Motion of tool point for G76 cycle. End Z position will be determined by G98/99 setting.

After feeding to the bottom of the hole, the machine will pause for the specified dwell time, then the spindle will stop in the orient position before making the shift move defined by I and J. In machines with a spindle orient function called by M19 this will all be automatic. However, many machines are not capable of orienting the spindle so the orientation must be done manually. Make an M code macro program M19.mcs to command a spindle stop and an M0 mandatory program stop. This will allow the operator to manually orient the spindle before the shift move is made. Here is an example of the M19 macro for the manual orient:

INSERT MANUAL M19 MACRO PROGRAM HERE

Example:

Create the program to fine bore the holes shown in figure 2.

G0 G90 G54 G17 G40 G49 G80	Safe start line
T1 M6	Tool change
S2500 M3	Start spindle
G0 X1.0 Y-1.0	Position to X and Y start point
G43 H1 Z.5	Activate tool offset 1 and move to Z initial point
G76 G99 X1.0 Y-1.0 Z-1.0 R.25 I-.025 J0 F10.0	Fine bore cycle, shift X-.025 at bottom
X2.0 Y-1.0	Bore second hole
X3.0 Y-1.0	Bore third hole
G80	Canned cycle cancel
G0 G53 Z0	Return Z to home
M30	Program end and rewind

G85 – Boring, Feedrate Retract: G85 is a straight boring cycle, most commonly used for boring or reaming. The retract is at the programmed feedrate with the spindle on.

G85 X__ Y__ Z__ R__ L__ F__

X, Y – Position of hole in XY plane

Z – End point of hole

R – Retract plane

L – Number of repetitions

F – Feedrate

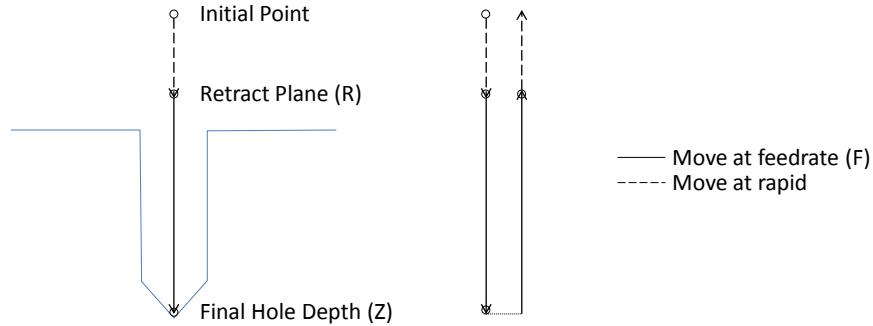

Figure 85-1: Motion of tool point for G85 cycle. End Z position will be determined by G98/99 setting.

Example:

Create the program to bore the holes shown in figure 2.

G0 G90 G54 G17 G40 G49 G80	Safe start line
T1 M6	Tool change
S2500 M3	Start spindle
G0 X1.0 Y-1.0	Position to X and Y start point
G43 H1 Z.5	Activate tool offset 1 and move to Z initial point
G85 G99 X1.0 Y-1.0 Z-1.0 R.25 F10.0	Boring cycle start
X2.0 Y-1.0	Bore second hole
X3.0 Y-1.0	Bore third hole
G80	Canned cycle cancel
G0 G53 Z0	Return Z to home
M30	Program end and rewind

G86 – Boring, Rapid Retract: G86 is a straight boring cycle. Before retracting from the hole the spindle is stopped. The retract is then performed at the rapid rate. This will leave a scratch or multiple scratches where the cutting edges are in contact with the wall.

G86 X__ Y__ Z__ R__ L__ F__

X, Y – Position of hole in XY plane

Z – End point of hole

R – Retract plane

L – Number of repetitions

F – Feedrate

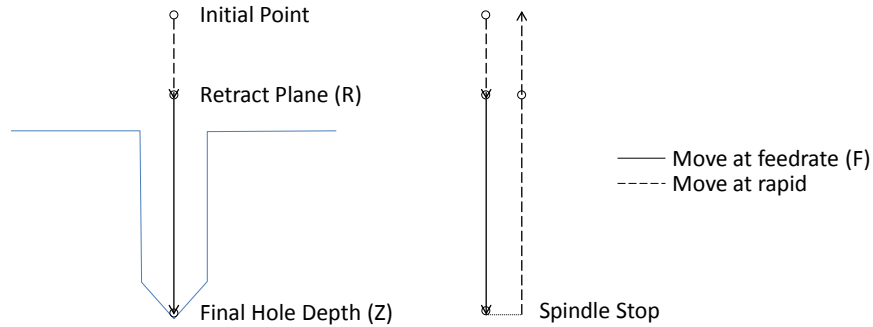

Figure 86-1: Motion of tool point for G86 cycle. End Z position will be determined by G98/99 setting.

Example:

Create the program to bore the holes shown in figure 2.

G0 G90 G54 G17 G40 G49 G80	Safe start line
T1 M6	Tool change
S2500 M3	Start spindle
G0 X1.0 Y-1.0	Position to X and Y start point
G43 H1 Z.5	Activate tool offset 1 and move to Z initial point
G86 G99 X1.0 Y-1.0 Z-1.0 R.25 F10.0	Boring cycle start
X2.0 Y-1.0	Bore second hole
X3.0 Y-1.0	Bore third hole
G80	Canned cycle cancel
G0 G53 Z0	Return Z to home
M30	Program end and rewind

G87 – Back Boring: G87 is a back boring cycle. This is a useful cycle for spot facing, counter boring or chamfering the back side of a part. At the start of the cycle the spindle will be stopped at the orient position and the tool offset from the hole center by the distance and direction defined by I and J. For machines that do not have the ability to orient the spindle, see the M19 macro example in the G76 cycle description. The tool can then be positioned to the R point below the work piece. Once at the R point the tool will be positioned at the hole center and the spindle started to perform the back boring operation. When the specified Z point is reached the machine will orient the spindle, offset by amount I, J and retract back to the initial point. In this cycle the R point will always be below the work piece, not a

good point the end the cycle. For that reason this canned cycled will always return to the initial point, it is not possible to specify a G99 R point return.

G87 X__ Y__ Z__ R__ I__ J__ P__ L__ F__

- X, Y – Position of hole in XY plane
- Z – End point of hole
- R – Retract plane
- I – X shift distance and direction
- J – Y shift distance and direction
- P – Dwell in seconds
- L – Number of repetitions
- F – Feedrate

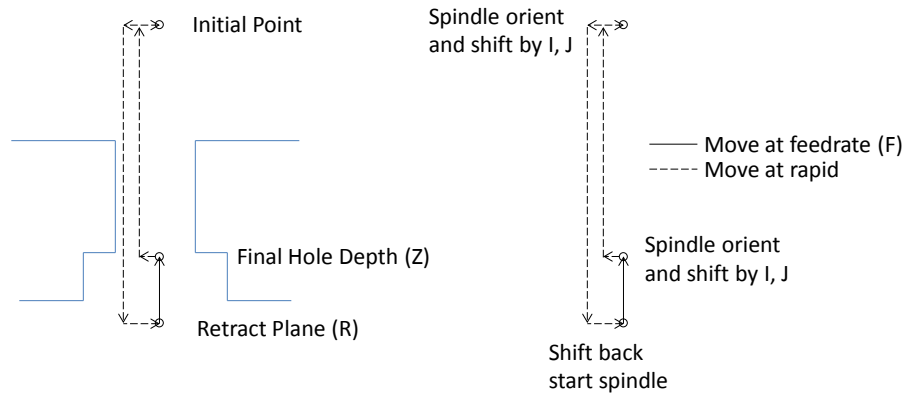

Figure 87-1: Motion of tool point for G87 cycle. End Z position will be determined by G98/99 setting.

Example:

Create the program to back bore thru holes at the same positions shown in figure 2. Thru depth 1 inch, back bore depth .150 inch.

G0 G90 G54 G17 G40 G49 G80	Safe start line
T1 M6	Tool change
S2500 M3	Start spindle
G0 X1.0 Y-1.0	Position to X and Y start point
G43 H1 Z.5	Activate tool offset 1 and move to Z initial point
G87 G98 X1.0 Y-1.0 Z-0.85 R-1.05 I-.10 F10.0	Back boring cycle start (Shift -.1 in X axis)
X2.0 Y-1.0	Bore second hole
X3.0 Y-1.0	Bore third hole
G80	Canned cycle cancel
G0 G53 Z0	Return Z to home

G88 – Boring, Manual Retract: This boring cycle features a manual retract. At the bottom of the hole the specified dwell is performed, then the spindle is stopped and the program paused. The operator can then manually retract the tool from the hole. After retracting the tool cycle start is pressed to continue program operation.

G88 X__ Y__ Z__ R__ P__ L__ F__

X, Y – Position of hole in XY plane

Z – End point of hole

R – Retract plane

P – Dwell in seconds

L – Number of repetitions

F – Feedrate

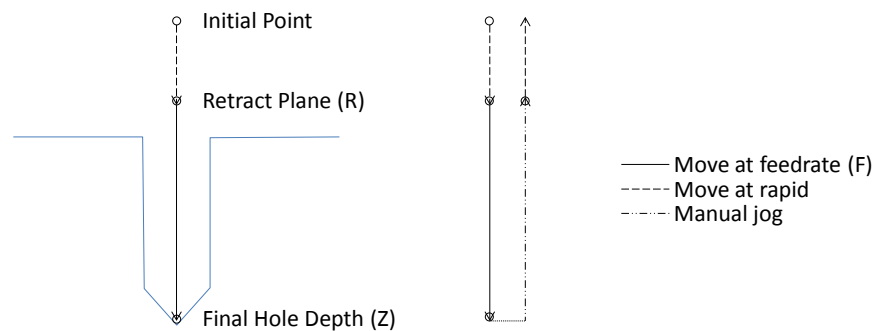

Figure 88-1: Motion of tool point for G85 cycle.

Example:

Create the program to bore the holes shown in figure 2.

G0 G90 G54 G17 G40 G49 G80	Safe start line
T1 M6	Tool change
S2500 M3	Start spindle
G0 X1.0 Y-1.0	Position to X and Y start point
G43 H1 Z.5	Activate tool offset 1 and move to Z initial point
G88 G99 X1.0 Y-1.0 Z-1.0 R.25 F10.0	Boring cycle start, pause for manual retract
X2.0 Y-1.0	Bore second hole, pause for manual retract
X3.0 Y-1.0	Bore third hole, pause for manual retract

G80	Canned cycle cancel
G0 G53 Z0	Return Z to home
M30	Program end and rewind

G89 – Boring, Dwell & Feedrate Retract: Same function as G85 with the addition of a dwell at the bottom of the hole.

G89 X__ Y__ Z__ R__ P__ L__ F__

X, Y – Position of hole in XY plane

Z – End point of hole

R – Retract plane

P – Dwell in seconds

L – Number of repetitions

F – Feedrate

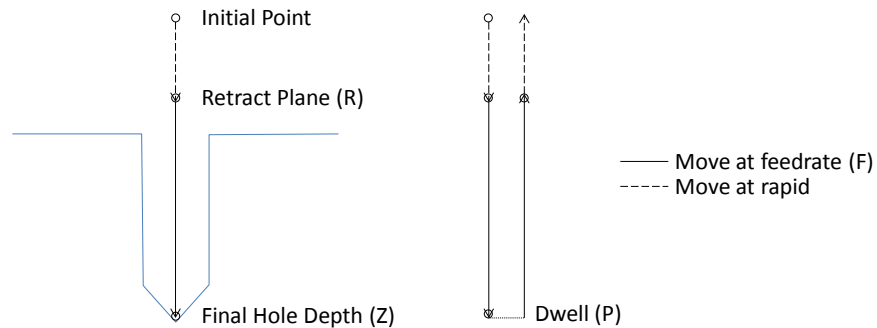

Figure 89-1: Motion of tool point for G89 cycle. End Z position will be determined by G98/99 setting.

Example:

Create the program to bore the holes shown in figure 2.

G0 G90 G54 G17 G40 G49 G80	Safe start line
T1 M6	Tool change
S2500 M3	Start spindle
G0 X1.0 Y-1.0	Position to X and Y start point
G43 H1 Z.5	Activate tool offset 1 and move to Z initial point
G89 G99 X1.0 Y-1.0 Z-1.0 R.25 P.250 F10.0	Boring cycle start
X2.0 Y-1.0	Bore second hole

X3.0 Y-1.0	Bore third hole
G80	Canned cycle cancel
G0 G53 Z0	Return Z to home
M30	Program end and rewind

Chapter 4: Cutter Compensation

Cutter compensation provides the user with the ability to adjust the tool path for variations in tool cutter diameter. It can be used in two ways. First, when programming by hand, without the aid of CAM (Computer Aided Manufacturing) software, it is much easier to program the actual part dimensions, part line programming. This saves the programmer from having to calculate the correct path at the center of the tool when the edge is doing the cutting. When given a proper diameter offset, cutter compensation will make the appropriate tool path adjustments to cut the part correctly. Essentially the machine does the math for the programmer. Second, with the more widespread use of CAM systems the tool path is already adjusted for the tool diameter and the part should, in theory, be cut perfectly to size. In practice however, there are many factors that determine the finished size of a machined part, cutter and machine deflection, machine positioning accuracy, cutter diameter variations, etc. Cutter compensation allows for fine tuning the tool path, and adjustment of part dimensions, without having to change the program itself.

There are two G codes used to enable cutter compensation. G41 offsets the tool to the left of the tool path and G42 offsets the tool to the right of the tool path. This is only true for positive diameter offset values. If negative offset is specified the offset direction will be reversed, see figure 41-1. There are two ways to call the offset value with G41 and G42.

Format 1: G00/G01 G41/G42 D__ X__ Y__ F__

Format 2: G00/G01 G41/G42 P__ X__ Y__ F__

Use D to call a diameter offset from a specific tool offset number. For example, D2 will use the diameter offset value of tool offset number 2. An alternative is to use P. The value specified with P will be the actual offset value. For example, P.05 will offset the tool path .05 to the left or right.

Cutter compensation only works on the two in plane axes, so for G17 (XY plane) the X and Y axes are affected by the comp, G18 ZX and G19 YZ.

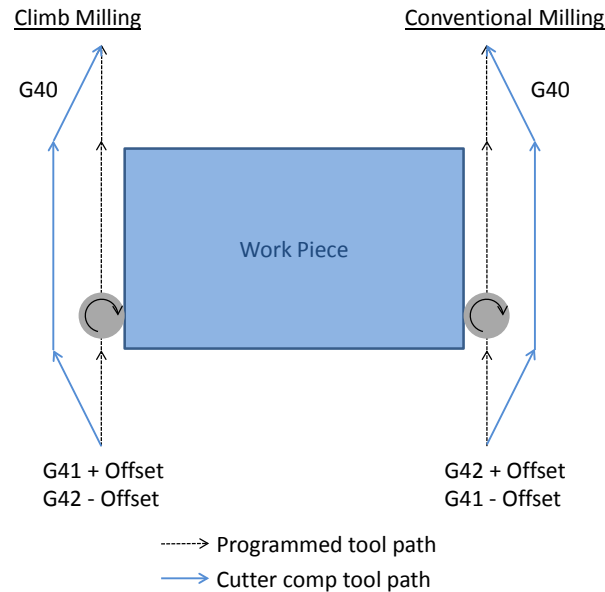

Figure 41-1: Cutter compensation offset direction.

There are two types of milling, which style is used determines how the tool should be compensated. The two types are climb milling and conventional milling, see figure 41-1. Conventional milling is the standard in manual machines, but with CNC it is possible and recommended to climb mill when possible. This manual will assume the tool will always be climb milling. With that assumption if G41 is used for outside features, the profile of a part, then a positive offset will make the part bigger and a negative offset will make the part smaller. For inside features, a hole, G42 will make the hole bigger with a positive offset and smaller with a negative offset, see figure 41-2. This method tends to make the offset values more intuitive for the operator. If conventional milling is used, this description will be reversed.

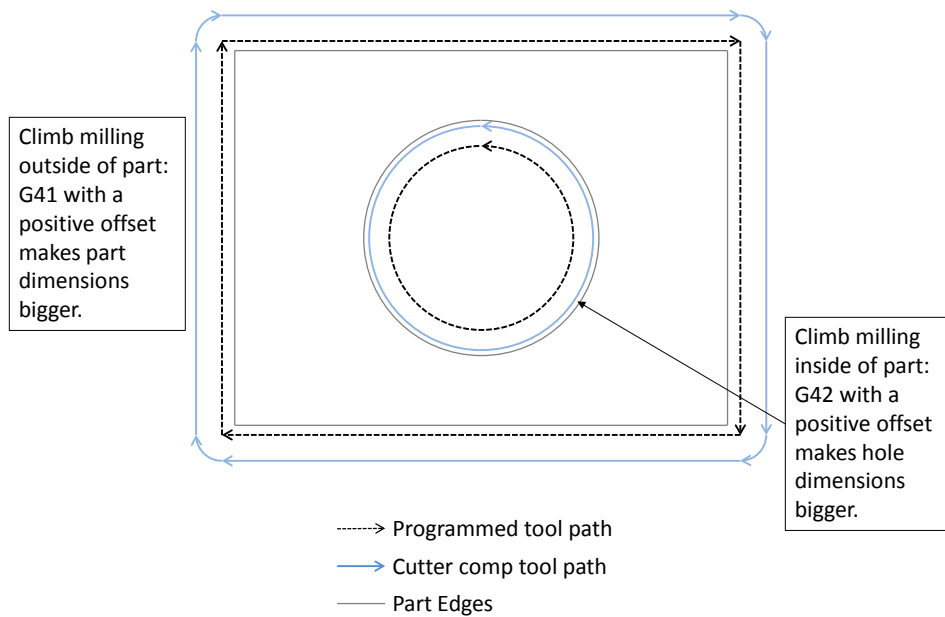
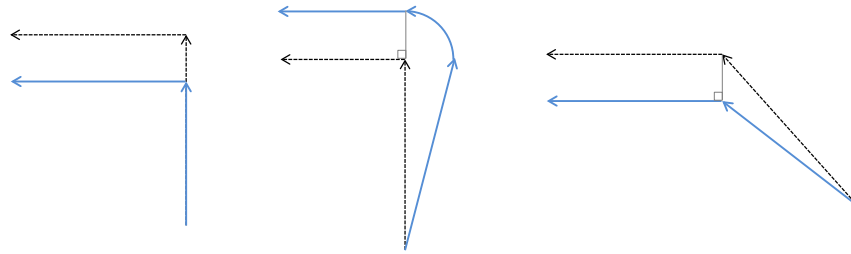

Figure 41-2: Cutter compensation OD and ID features.

Cutter comp should be enabled on a linear lead-in move; an error will be produced if cutter comp is enabled in a block with an arc. If there is a value other than zero in the offset then this lead-in move may not be parallel to the programmed path, see figure 41-1, 41-6 and 41-7. The end point of the start block is the point at a 90° angle to the movement in the next block and at the offset distance. See figure 41-3 for examples. This linear move must be longer than the offset amount, if it is not there will be an error. Also, if there are any segments of the tool path shorter than the offset amount a gouge is likely, see figure 41-4. The tool path display in Mach will display the actual tool path with comp, check to make sure there are no gouges or abnormalities before running a part.



-----> Programmed tool path
 ———> Cutter comp tool path

Figure 41-3: Cutter compensation start blocks.

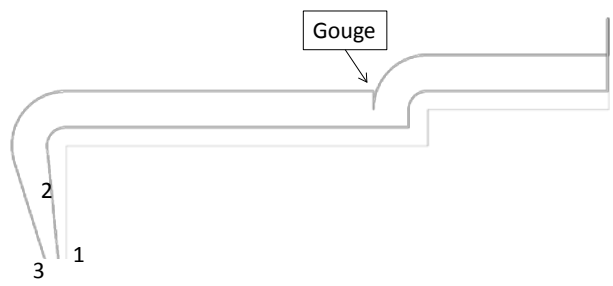

<p><u>Tool Path 1: No cutter comp</u> G00 G90 G54 G17 G40 G49 G80 G0 X0 Y0 Z1. S1000 M3</p> <p>G1 G41 P0 Y.5 F25. X1.5 Y.6 X2.0 G40 Y1.25</p> <p>M30</p>	<p><u>Tool Path 2: Comp radius .05</u> G00 G90 G54 G17 G40 G49 G80 G0 X0 Y0 Z1. S1000 M3</p> <p>G1 G41 P0.05 Y.5 F25. X1.5 Y.6 X2.0 G40 Y1.25</p> <p>M30</p>	<p><u>Tool Path 3: Comp radius .15</u> G00 G90 G54 G17 G40 G49 G80 G0 X0 Y0 Z1. S1000 M3</p> <p>G1 G41 P0.15 Y.5 F25. X1.5 Y.6 X2.0 G40 Y1.25</p> <p>M30</p>
---------------------------------------------------------------------------------------------------------------------------------------------------------------------------------------------------------------------------------------	-------------------------------------------------------------------------------------------------------------------------------------------------------------------------------------------------------------------------------------------	-------------------------------------------------------------------------------------------------------------------------------------------------------------------------------------------------------------------------------------------

Figure 41-4: Cutter compensation radius and gouge.

Figure 41-4 shows three tool paths generated by the same program with different cutter compensation offset values. The gouge is created when an offset value greater than the step of .10 is input. When this happens the compensated tool path over laps and is reversed, causing a gouge. Another example of this is in small grooves as shown in figure 41-5.

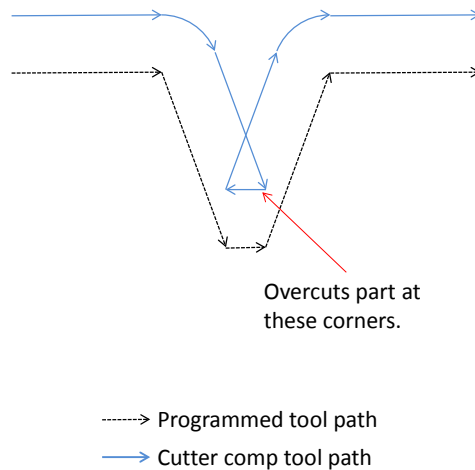

Figure 41-5: Cutter compensation in narrow groove.

Cutter compensation is cancelled by specifying G40 in the program, or when the control is reset. When G40 is specified it should be on a lead-out move following the same rules as when compensation is enabled. The path will be determined as shown in figure 41-3. Errors will occur if the lead-out distance is smaller than the offset amount or if G40 is specified on a block containing an arc move.

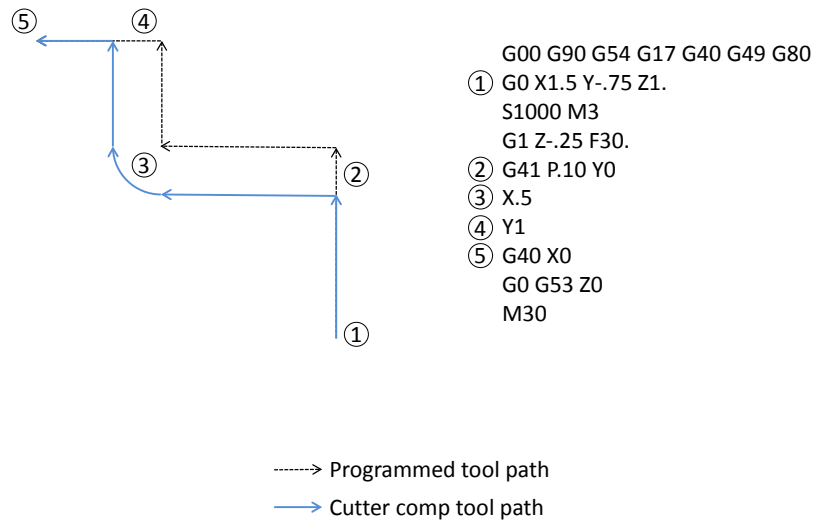

Figure 41-6: G41 cutter compensation path.

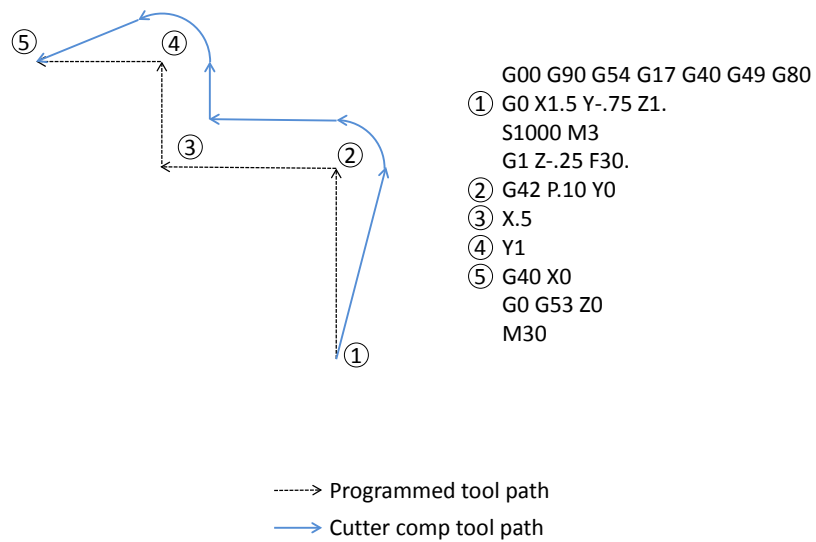

Figure 41-7: G42 cutter compensation path.

Chapter 5: M Code List

Code	Description	Page
M00	Mandatory Program Stop	56
M01	Optional Program Stop	56
M02	Program End	56
M03	Spindle Forward/Clockwise	56
M04	Spindle Reverse/Counterclockwise	56
M05	Spindle Stop	56
M06	Tool Change	57
M07	Mist Coolant On	57
M08	Flood Coolant On	57
M09	All Coolant Off	57
M19	Spindle Orient	
M30	Program End and Rewind	57
M48	Enable Feed/Speed Overrides	57
M49	Disable Feed/Speed Overrides	57
M98	Subprogram Call	57
M99	Return From Subprogram / Rewind	59
M???	Custom Macro M Codes	60

M Code Descriptions

M00 – Mandatory Program Stop: To pause a program at any point specify an M00. All motion will be halted and the spindle stopped. To resume operation press the cycle start button.

M01 – Optional Program Stop: Program pauses same as M00, but only when the optional stop switch is turned on. This allows the operator to stop and check program points when needed, but also to run without stops.

M02 – Program End: Ends the program at the M02 block. All program operation will be ended and defaults (G54, G17, G90, etc.) reset. The program will not rewind and if the cycle start button is pressed program operation will begin with the next block following the M02.

M03 – Spindle Forward/Clockwise: Turns the spindle on in the forward direction at the designated speed. M03 is usually combined with an S word to define the speed. If an S word is not specified the last spindle speed is used.

M04 – Spindle Reverse/Counterclockwise: Turns the spindle on in the reverse direction at the designated speed. M04 is usually combined with an S word to define the speed. If an S word is not specified the last spindle speed is used.

M05 – Spindle Stop: Stops spindle rotation.

M06 – Tool Change: Tells the machine to change to a tool number specified by T. The T word must appear in the same block as the M06 or above it in the program. For example:

G0 G90 G54 G17 G40 G49 G80	Safe start line
G0 X4.0 Y0.0 Z1.0 T1	Rapid move, pre call tool 1
M6	Tool change to tool 1
G0 X10.0 Y-5.0 Z1.0	Rapid move
T2 M6	Tool change to tool 2
M30	Program end and rewind

M07 – Mist Coolant On: Turns on the mist coolant output.

M08 – Flood Coolant On: Turns on the flood coolant output.

M09 – All Coolant Off: Turns off all coolant outputs.

M19 – Spindle Orient: Although this code is not built into Mach and is completely user defined, it is required to orient the spindle for some machining cycles, G76 and G87 for example. Tool changers usually will require a spindle orientation, and although this orientation could be any M code defined by the user or even built into the M6, M19 is recommended as it is an industry standard M code.

M30 – Program End and Rewind: Ends the current program and rewinds back to the beginning. Pressing the cycle start button will start program execution from the first block. All defaults (G54, G17, G90, etc.) will be reset.

M48 – Enable Feedrate/Spindle Speed Overrides: Enables the feedrate and spindle speed overrides after an M49 has been issued.

M49 – Disable Feedrate/Spindle Speed Overrides: Disables the feedrate and spindle speed overrides. This can be beneficial in production environments and also in programs or macros that are sensitive to feedrate and spindle speed by preventing accidental overrides.

M98 – Subprogram Call: Subprograms are external programs referenced by the current running program. When called program execution will continue in the subprogram. This allows the user to reduce program length and complexity by providing the ability to easily repeat sections of code, run the same section of code in multiple locations or in multiple fixture offsets, the possibilities are limited only by the programmer. To call a subprogram command M98 with the program number as shown.

Format: M98 P____ Q__ L__

P specifies the number of the program to be called. This is a four digit integer number. When the M98 is read Mach scans the current file for a block containing the program number in the following form:

Format: O1234

Note that the letter “O” is used to specify the program number 1234, NOT the number “0”. Program execution will continue with the block following the O number. For this method the subprogram should be below the end of the current program:

(MAIN PROGRAM)	Main program header
G0 G90 G54 G17 G40 G49 G80	Safe start line
G0 X4.0 Y0.0 Z1.0	Rapid move
T1 M6	Tool change to tool 1
G0 X10.0 Y-5.0 Z1.0	Rapid move
M98 P1000	Call subprogram number 1000
M30	Program end and rewind
O1000 (SUB PROGRAM BEGIN)	Subprogram number
G12 I-0.25	Cut circle
M99	Return to main program

There are limitations to this method; mainly the subprogram must be pasted into every program that it is to be called from. Mach also allows a subprogram to be called from an external file. This way, multiple programs can call the same subprogram, without having the program in the main file. If a change needs to be made to the subprogram it only needs to be done in one file, not every file in which the sub is called. If the control does not find the program number in the current file it will then search for it in the Mach4\Subroutines directory. This time it will be searching filenames. The files in this directory should be named with the program number as follows:

Format: O_____

Note the letter “O” followed by four numbers, and no file extension; O1234 not O1234.txt. When the program is loaded this file will be found and loaded into the memory, the tool path display will reflect what is in the subprogram. When running the file the M98 block will be read and program execution will continue with the first block of the subprogram file.

The arguments Q and L are optional. Q specifies the sequence number in the subprogram to start at. If Q is omitted then execution will start at the beginning of the sub program; see figure 198-1. L is the number of repetitions. For example, if L=2 the subprogram is run two times before execution of the main program continues. If L is omitted the program will run only once.

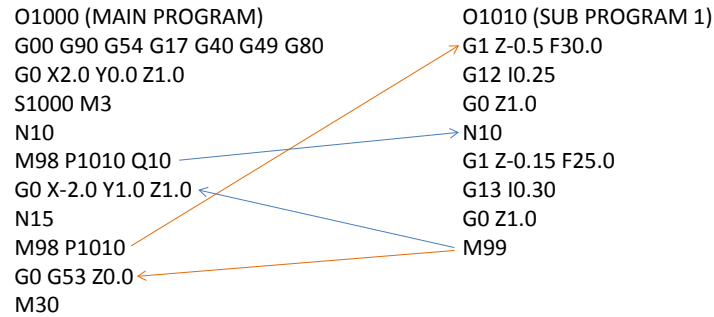

Figure 198-1: Subprogram call

M99 – Return From Subprogram / Rewind: To return to the main program from a subprogram an M99 is used.

Format: M99 P__

M99 specified in a subprogram will return to the main program at the block immediately following the M98 subprogram call. The addition of a P in the M99 block will return to a desired sequence number in the main program. See figure 199-1.

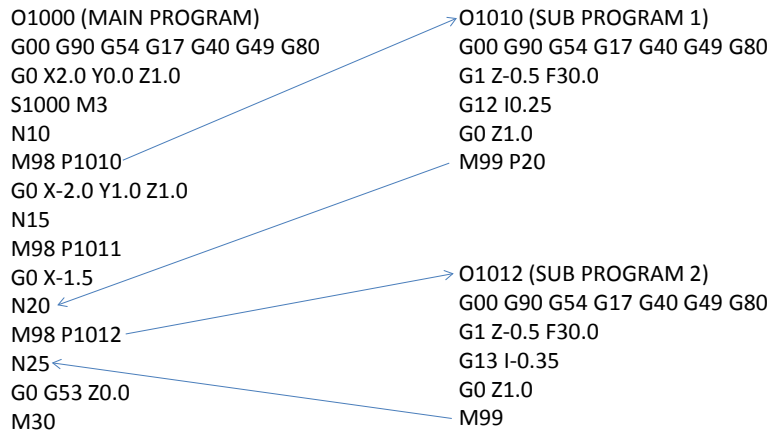

Figure 199-1: Return from sub program

If M99 is specified in a main program (not in a subprogram) a program rewind is performed. Execution will continue from the first block of the program.

Custom M Codes: Every machine is a little different and has different functions and options. Custom M codes allow the user to create simple programming calls for complex processes, activating or deactivating outputs, reading inputs, performing math, or whatever else the user and machine could require. These M codes are programmed in Lua and placed in the macros folder under each profile. Every profile can have its own unique set of M codes. The file name must be the macro to be called. For example to make a tool change macro, M6, add a Lua script with the filename M6.mcs to the macros folder in the desired profile. When an M6 is called in a program or in MDI the macro will be executed.